

CINI & NILS



*Lo spazio della luce è illimitato, dinamico e trasmissivo.
Ogni nostra collezione racconta una storia di sperimentazione tra visibile e invisibile, e tutta la qualità del Made in Italy.*

*The space of light is unlimited, dynamic and transmissive.
All our collections tell stories about experimenting between visible and invisible, and about the quality of Made in Italy.*

5 Company

11 Designers

17 Collections

Interior

20	Flip	222	Componi200
36	Sottile	230	Componi75
44	Fischietto	236	TensoStilo
50	Anda	244	TensoSpot
58	Indice	248	newTensoled
66	Manhattanhenge	252	TensoFari
72	Ognidove	258	newTensoGradi
82	Roma	262	miniTensoSferico
86	Sferico	268	miniTensoOnirico
90	Fludd	272	miniTensoFari
96	Stilo	282	Fari
102	Acqua	286	miniFari
112	Passepartout		
138	Bouquet		
146	Cuboluca		
154	Incontro		
162	Assolo	72	Ognidove
180	FormaLa	176	Assolo
190	Sestessa	276	TensEsterni
206	Gradi		
216	Convivio		

Outdoor

Company

Storia / history

Cini&Nils nasce nel 1969 dalla volontà di due designer che sentono l'esigenza di proporre i propri progetti direttamente ai fruitori. Mario Melocchi, insieme all'architetto e designer Franco Bettonica, fonda la società proponendo inizialmente diversi oggetti, molti acquisiti dal MoMA di New York, quali le collezioni da Bar, da Tavola, da Scrivania, il Portariviste girevole, il Cubobar, il Tavolo da Gioco. Nel 1972, da un'idea di Franco Bettonica, nasce Cuboluce, anello di congiunzione tra oggetti e apparecchi illuminanti e capostipite di una nuova generazione di prodotti che segnano l'ingresso di Cini&Nils nel campo dell'illuminazione. Negli anni seguono molte innovazioni e la proprietà passa ai manager che hanno contribuito al suo sviluppo. Con la direzione artistica di Luta Bettonica, le nuove collezioni led segnano la svolta verso una produzione innovativa, sostenibile e interconnessa. Nota per i suoi prodotti che hanno fatto storia, Cini&Nils, con 50 anni di presenza sul mercato, si consolida come punto di riferimento nel campo dell'illuminazione decorativa e tecnica di alta gamma.

Cini&Nils was established in 1969 when two designers felt the need to make their designs directly available to the market. When Mario Melocchi teamed up with the architect and designer Franco Bettonica to found the company, the duo started out by marketing a range of products, many of which have since been bought by the New York MoMA, including the Bar, Tabletop and Desktop collections, the swivel Magazine Stand, the Cubobar and the Game Table. It was in 1972 that Franco Bettonica came up with the idea for Cuboluce, the link in the chain between objects and lighting devices and the progenitor of a new generation of products that marked Cini&Nils' début in the field of lighting. One innovation followed another, year after year, and in due course ownership of the firm passed to the managers who had contributed to its success. Under the artistic direction of Luta Bettonica the new led collections have turned over a new page towards innovative, sustainable and interconnected production. Renowned for products that have made history in its 50 years of market presence, Cini&Nils has become a familiar benchmark in the field of high-end decorative and technical lighting.

Cini&Nils entstand 1969 auf Initiative von zwei Designern, die ihre Ideen nicht mehr über Dritte, sondern dem Publikum direkt anbieten wollten. Mario Melocchi gründet die Gesellschaft gemeinsam mit dem Architekten und Designer Franco Bettonica. Anfangs entwerfen sie diverse Gebrauchsgegenstände, von denen sich viele heute im New Yorker MoMA ausgestellt finden, etwa die Bar-, Esstisch- und Schreibtischkollektionen, der drehbare Zeitschriftenständer, der Barwürfel „Cubobar“ oder der Kartenspieltisch. 1972 entsteht nach einer Idee von Franco Bettonica die Würfelleuchte „Cuboluce“, die sich als Bindeglied zwischen dem Design von Gebrauchsgegenständen und dem von Leuchten sowie als Stammvater einer neuen Generation von Produkten erweisen sollte, mit denen sich Cini&Nils auf Beleuchtungslösungen spezialisiert. Im Laufe der Zeit folgen zahlreiche bahnbrechende Innovationen, und die Gesellschaft geht in den Besitz der Führungskräfte über, die über die Jahre zu ihrem Aufstieg beigetragen haben. Unter der künstlerischen Leitung von Luta Bettonica markieren die neuen led Kollektionen den Wendepunkt zu einer innovativen, nachhaltigen und vernetzten Produktpalette. Bekannt für zahlreiche Produkte, die die Geschichte geschrieben haben, hat sich Cini&Nils mit seiner 50-jährigen Marktpräsenz als feste Größe im Bereich dekorativer und technischer Beleuchtungslösungen des Premiumsegments etabliert.

Cini&Nils est née en 1969 par la volonté de deux designers, déterminés à proposer leurs propres projets directement aux utilisateurs. Mario Melocchi, en collaboration avec l'architecte et designer Franco Bettonica, a fondé la société en proposant initialement différents produits, dont nombreux ont été acquis par le MoMA de New York, tels que les collections pour le Bar, la Table, le Bureau, le Porte-revues pivotant, Cubobar, la Table de jeu. En 1972 d'une idée de Franco Bettonica, est née Cuboluce, trait d'union entre objet et lumière et fondatrice d'une nouvelle génération de produits qui marquent l'entrée de Cini&Nils dans le monde de l'éclairage. Au fil des années, de nombreuses innovations ont suivi et la propriété est passée aux gestionnaires qui ont contribué à son développement. Sous la direction artistique de Luta Bettonica, les nouvelles collections led marquent un tournant décisif vers une production innovante, durable et interconnectée. Renommée pour ses produits qui ont fait l'histoire, Cini&Nils, forte de 50 ans de présence sur le marché, s'est consolidée pour devenir une référence dans le domaine de l'éclairage décoratif et technique haut de gamme.

Cini&Nils nace en el año 1969 por voluntad de dos diseñadores que sienten la exigencia de proponer sus propios proyectos directamente a los consumidores. Mario Melocchi, junto con el arquitecto y diseñador Franco Bettonica, funda la sociedad presentando al inicio diferentes objetos, muchos de los cuales han sido incluidos en el MoMA de Nueva York, como las colecciones de Bar, de Mesa, de Escritorio, el Revistero giratorio, el Cubobar, la Mesa de juego. En 1972, de una idea de Franco Bettonica, nace Cuboluce, anillo de conjunción entre objetos y aparatos iluminantes y precursor de una nueva generación de productos que marcan la entrada de Cini&Nils en el campo de la iluminación. A lo largo del tiempo en la compañía se subsiguen muchas innovaciones y la propiedad pasa a manos de los directivos, quienes en los años han contribuido a su desarrollo. Con la dirección artística de Luta Bettonica, las nuevas colecciones led marcan el cambio hacia una producción innovadora, sostenible e interconectada. Conocida por sus productos que han hecho historia, Cini&Nils, con 50 años de presencia en el mercado, se consolida como punto de referencia en el sector de la iluminación decorativa y técnica de alta gama.

1968 forbici e apribuste, 1969 collezione da bar, 1972 olio+aceto, sale+pepe, 1972 cuboluce, 1973 cubobar, 1975 posacenere nautico.
Oggetti e mobili non sono più in produzione. The objects and furnishings are no longer in production. Die Designobjekte und Möbelstücke sind heute nicht mehr in Produktion.
Les objets et les meubles ne sont plus produits. Objetos y muebles ya no están en producción.

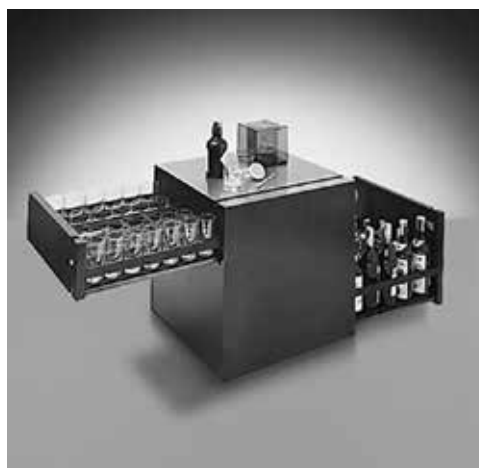



Luce / light

La luce condiziona la nostra qualità di vita e le opportunità tecnologiche ci avvicinano ad essa in modo nuovo. I prodotti Cini&Nils di ultima generazione sono interconnessi ai più diffusi dispositivi intelligenti. Scenari luminosi variabili e interazioni wireless fanno parte della nuova quotidianità che Cini&Nils propone. La scelta dei componenti mira al benessere dell'uomo e il laboratorio di Ricerca&Sviluppo analizza, seleziona e propone solo le migliori tecnologie. Attraverso costanti prove di laboratorio, verifica l'assenza di fenomeni di sfarfallio (flickering) per evitare stress e fastidi ottici. Con le sue selezionate proposte, assicura il naturale rispetto della percezione dei colori e la corretta illuminazione dell'ambiente.

Light conditions the quality of our lives and technological opportunities enable us to approach it in new ways. The latest generation of products from Cini&Nils is interconnected with the most widely available intelligent devices. Variable light scenarios and wireless interaction are part of the new everyday life on offer from Cini&Nils. Our choice of components aims at human wellness, while our Research&Development laboratory analyses, selects and proposes only the best technologies. Constant laboratory tests are used to check the absence of flicker, so as to avoid optical disturbances and stress. The Cini&Nils product range ensures a natural respect for colour perception and the right degree of illumination in each environment.

Licht bedingt unsere Lebensqualität in erheblichem Maße, und die heutigen technischen Möglichkeiten erlauben uns einen neuartigen Zugang zu ihm. Die Cini&Nils Produkte neuester Generation sind mit den meisten marktüblichen Smartgeräten vernetzbar. Variable Lichtszenarien und drahtlose Verbindungen sind Teil des heutigen Alltags, der sich mit Cini&Nils Lösungen gestalten lässt. Die Auswahl aller Komponenten zielt auf das größtmögliche Wohlbefinden für den Menschen ab, und unsere Forschungs- und Entwicklungsabteilung zieht nur die hierfür bestgeeigneten Technologien in Betracht, prüft sie und setzt sie um. Durch kontinuierliche Labortests wird die Abwesenheit von Flickererscheinungen sichergestellt, um eine Stressbelastung und optische Störungen für den Nutzer zu verhüten. Sorgfältig ausgewählte Lösungen sorgen für eine natürliche Farbwahrnehmung und eine korrekte Umgebungsbeleuchtung.

La lumière conditionne notre qualité de vie et les opportunités technologiques nous en rapprochent d'une nouvelle manière. Les produits Cini&Nils de dernière génération sont interconnectés aux appareils intelligents les plus répandus. Les décors de luminosité variables et les interactions sans fil font partie de la nouvelle

vie quotidienne proposée par Cini&Nils. Le choix des composants est lié au bien-être humain et le laboratoire Recherche&Développement analyse, sélectionne et propose uniquement les meilleures technologies. Grâce à des tests de laboratoire constants, il vérifie l'absence de phénomènes de scintillement (flickering) pour éviter le stress et l'inconfort visuel. Avec ses propositions sélectionnées il assure le naturel respect de la perception des couleurs et le bon éclairage de l'environnement.

La luz condiciona nuestra calidad de vida y las oportunidades tecnológicas nos acercan a ella de modo nuevo. Los productos Cini&Nils de última generación están interconectados con los dispositivos inteligentes más comunes. Los ambientes luminosos variables y las interacciones inalámbricas son parte de la nueva vida cotidiana que propone Cini&Nils. La elección de los componentes tiene como objetivo el bienestar del ser humano y el laboratorio de Investigación y Desarrollo analiza, selecciona y propone solo las mejores tecnologías. A través de continuas pruebas de laboratorio, verifica la ausencia de fenómenos de parpadeo para evitar estrés y molestias ópticas. Con sus propuestas seleccionadas, garantiza el natural respeto de la percepción del color y la correcta iluminación del ambiente.

Qualità / quality Made in italy

Cini&Nils ha fatto della qualità uno dei suoi punti di forza. Lo stretto rapporto con i migliori artigiani italiani ha contribuito alla creazione delle eccellenze qualitative che contraddistinguono l'esclusività del prodotto. La condivisione delle esperienze, la collaborazione e la ricerca delle migliori soluzioni, per il raggiungimento di sempre nuovi obiettivi, alimentano il know-how produttivo acquisito in cinquant'anni di esperienza. Ogni collezione nasce quindi da mani esperte e dall'utilizzo dei macchinari più all'avanguardia che portano a formare un'opera compiuta fatta di dettagli e singoli elementi espressione della cultura dell'alta manifattura italiana. Alla fine di ogni processo produttivo ogni lampada supera rigorosi controlli di qualità in modo da garantire eccellenza e alte prestazioni.

Cini&Nils has made quality into one of its strong points. The firm's close relationship with the finest Italian craftsmen has contributed to creating the excellent quality that distinguishes its products' exclusiveness. Shared experiences, collaboration and the quest for the best solutions to achieve a constant stream of new





targets feed the production knowhow acquired in fifty years of experience. This means that every collection is the offspring of expert hands and the use of state-of-the-art machinery that together lead to the creation of a complete work of skill, comprising details and individual elements that express the finest culture of Italian manufacturing. At the end of every production process, every luminaire has to pass stringent quality control tests, so as to guarantee excellence and high performance.

Die herausragende Qualität seiner Produkte ist eine der besonderen Stärken von Cini&Nils. Die enge Zusammenarbeit mit den besten italienischen Handwerksbetrieben hat zur Entstehung der qualitativen Exzellenz beigetragen, die die Exklusivität unserer Produkte ausmacht. Erfahrungsaustausch, Zusammenarbeit und die Suche nach den besten Lösungen zur Erreichung immer wieder neuer Ziele speisen das umfassende, in fünfzig Jahren erworbene Know-how in puncto Verarbeitung und Produktion. Jede Kollektion entsteht so durch fachkundige Handarbeit und den Einsatz modernster Maschinen als ein Gesamtwerk aus zahlreichen Einzelelementen und bringt die Kultur höchster italienischer Fertigungskunst zum Ausdruck. Am Ende jedes Produktionsabschnitts werden sämtliche Leuchten strengsten Qualitätskontrollen unterzogen, um Exzellenz und optimale Leistungswerte zu gewährleisten.

Cini&Nils a fait de la qualité l'un de ses atouts. Les relations étroites avec les meilleurs artisans italiens ont contribué à la création des excellences au niveau de la qualité qui distinguent l'exclusivité du produit. Le partage des expériences, la collaboration et la recherche des meilleures solutions pour la réalisation d'objectifs toujours nouveaux, alimentent le savoir-faire productif acquis en cinquante ans d'expérience. Chaque collection est donc née de mains expertes et de l'utilisation des technologies de pointe, pour réaliser une œuvre complète faite de détails et de divers éléments, expression de la culture de la haute manufacture italienne. À la fin de chaque processus de production, chaque lampe subit des contrôles de qualité très stricts pour atteindre les plus hauts niveaux de performance et d'excellence.

Cini&Nils ha hecho de la calidad una de sus fortalezas. La estrecha relación con los mejores artesanos italianos ha contribuido a crear excelencias cualitativas que caracterizan la exclusividad del producto. La compartición de las experiencias, la colaboración y la búsqueda de las mejores soluciones, para alcanzar cada vez nuevos objetivos, alimentan el know-how productivo adquirido en cincuenta años de experiencia. Cada colección es fruto de manos expertas y del uso de máquinas siempre a la vanguardia que llevan a dar vida a una obra hecha de detalles y elementos únicos, expresión de la cultura de la excelente manufactura italiana. Al final de cada proceso productivo, cada lámpara supera estrictos controles de calidad, de modo de garantizar excelencia y altas prestaciones.

Designers

Dal lavoro congiunto di Franco Bettonica e Mario Melocchi nascono innovazioni che segnano la storia dell'illuminazione come Cuboluce, Gradi, Tenso e TensoClic. Luta Bettonica progetta prodotti come Convivio, Assolo e Acqua. Nel 2018 Cini&Nils si avvale di una nuova sinergica collaborazione, l'architetto Alessandro Scandurra SSA e nel 2020 dell'Architetto Giancarlo Leone.

Working as a team, Franco Bettonica and Mario Melocchi created innovations that wrote chapters in the history of lighting: Cuboluce, Gradi, Tenso and TensoClic. Luta Bettonica has since designed such products as Convivio, Assolo and Acqua. In 2018 Cini&Nils embarked on a new synergic partnership with the architect Alessandro Scandurra SSA and in 2020 with the architect Giancarlo Leone.

Aus der Zusammenarbeit von Franco Bettonica und Mario Melocchi sind Innovationen hervorgegangen, die in puncto Design und Beleuchtung Geschichte geschrieben haben, wie etwa Cuboluce, Gradi, Tenso und TensoClic. Luta Bettonica hat Produkte wie Convivio, Assolo und Acqua entworfen. 2018 hat Cini&Nils eine neue fruchtbare Zusammenarbeit mit dem Architekten Alessandro Scandurra vom Büro SSA aufgenommen sowie 2020 auch mit dem Architekten Giancarlo Leone.

Du travail commun de Franco Bettonica et Mario Melocchi sont nées des innovations qui marquent l'histoire de la lumière, telles que Cuboluce, Gradi, Tenso et TensoClic. Luta Bettonica a conçu des produits tels que Convivio, Assolo et Acqua. En 2018 Cini&Nils a recours à une nouvelle collaboration synergique avec l'architecte Alessandro Scandurra SSA et en 2020 avec l'architecte Giancarlo Leone.

Fruto del trabajo conjunto de Franco Bettonica y Mario Melocchi son las innovaciones que marcan la historia de la iluminación, como Cuboluce, Gradi, Tenso y TensoClic. Luta Bettonica diseña productos como Convivio, Assolo, y Acqua. En 2018 Cini&Nils se enriquece con una nueva sinérgica colaboración, la del arquitecto Alessandro Scandurra SSA, y en 2020 se sumará al grupo el arquitecto Giancarlo Leone.

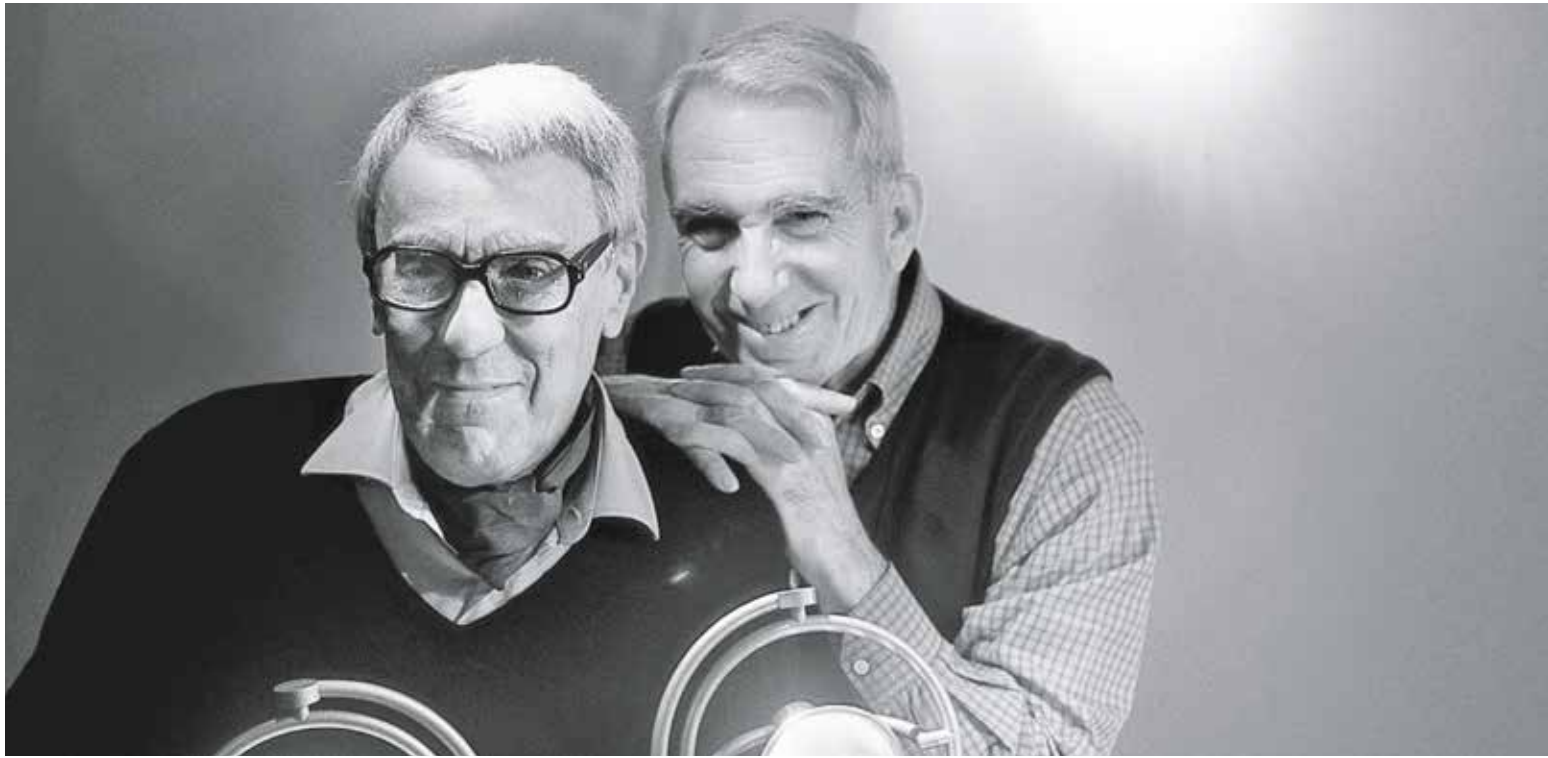

Mario Melocchi, Franco Bettonica

Mario Melocchi (Parma, 1931 - Milano, 2013), nel 1958 è tra i primi in Europa a dedicarsi al packaging design dal quale si evolve avvicinandosi gradualmente al product design, per approdarvi definitivamente dopo avere incontrato Franco Bettonica.

Franco Bettonica (Milano, 1927 - Milano, 1999), architetto, opera con successo nell'edilizia, nell'arredamento e nel disegno industriale. Dal 1969 ha collaborato con Cini&Nils in veste di progettista e direttore creativo.

Mario Melocchi (Parma, 1931 – Milan, 2013) was one of the first in Europe – in 1958 – to devote his attention to packaging design, from which his interested in due course evolved towards product design, where it settled once and for all after he met Franco Bettonica.

Franco Bettonica (Milan, 1927 – 1999) was an architect with a successful practice in construction, interiors and industrial design. He started working with Cini&Nils in 1969 as designer and creative director.

Mario Melocchi (Parma 1931 – Mailand 2013) gehörte 1958 zu den Ersten in Europa, die sich mit Verpackungsdesign beschäftigen. Von dort aus näherte er sich allmählich dem Produktdesign an, wo er schließlich seine Heimat fand, nachdem er Franco Bettonica kennen lernte.

Franco Bettonica (Mailand 1927 – Mailand 1999), Architekt, wirkte erfolgreich im Baugewerbe, als Innenarchitekt und als Industriedesigner. Von 1969 an arbeitete er mit Cini&Nils als Designer und Kreativdirektor zusammen.

Mario Melocchi (Parma, 1931 - Milan, 2013), en 1958, est l'un des premiers en Europe à s'occuper de packaging industriel à partir duquel il évolue progressivement vers le product design, et se spécialise définitivement, après avoir rencontré Franco Bettonica.

Franco Bettonica (Milan, 1927 - Milan, 1999), architecte, travaille avec succès dans le bâtiment, le décor et le design industriel. À partir de 1969, il collabore avec Cini&Nils en tant que concepteur et directeur de la création.

Mario Melocchi (Parma, 1931- Milán, 2013), en 1958, es uno de los primeros en Europa que se dedica al diseño de embalajes para luego pasar gradualmente al diseño de productos, consolidándolo definitivamente después de haber encontrado a Franco Bettonica.

Franco Bettonica (Milán, 1927- Milán, 1999), arquitecto, trabaja exitosamente en el ámbito de la construcción, de la decoración y del diseño industrial. En 1969 inicia su colaboración en Cini&Nils como proyectista y director creativo.

Luta Bettonica

Luta Bettonica si diploma in Disegno Industriale all'Istituto Europeo di Design e nel 1991 inizia l'attività di libera professionista. Franco Bettonica e Mario Melocchi sono stati i suoi primi interlocutori progettuali e nel 1996, con l'architetto Giancarlo Leone, apre a Milano lo studio di architettura e design Bettonica Leone. Opera principalmente nel settore illuminotecnico e, con Cini&Nils, ha realizzato prodotti dall'alto profilo innovativo che sono il frutto di un intenso lavoro di ricerca e sperimentazione sulla luce e sulle tecnologie.

Luta Bettonica started working as a freelance designer after taking her diploma in industrial design from the Istituto Europeo di Design in 1991. With Franco Bettonica and Mario Melocchi as her earliest design mentors, she and the architect Giancarlo Leone opened the "Studio Bettonica Leone" in 1996. Working mainly in the lighting sector, with Cini&Nils she has designed lamps with a very innovative content, the results of a long process of research and experimentation with light and technologies.

Luta Bettonica machte an der Designschule Istituto Europeo di Design (IED) ihren Abschluss in Industriedesign und wirkte ab 1991 zunächst freischaffend. Franco Bettonica und Mario Melocchi waren ihre ersten Projektpartner, und im Jahr 1996 eröffnete sie zusammen mit dem Architekten Giancarlo Leone in Mailand das Architekten- und Designbüro Bettonica Leone. Sie wirkt vorwiegend im Beleuchtungssektor und hat mit Cini&Nils Produkte von hohem Innovationswert geschaffen, die das Ergebnis intensiver Forschungs- und Erprobungsarbeiten zu Licht und seinen technologischen Anwendungsmöglichkeiten darstellen.

Luta Bettonica a obtenu son diplôme en design industriel à l'Istituto Europeo di Design et en 1991 elle commence à travailler comme indépendante dans le domaine du design. Franco Bettonica et Mario Melocchi seront ses premiers partenaires de projet. En 1996, en collaboration avec l'architecte Giancarlo Leone, elle ouvre à Milan le cabinet d'architecture et design Bettonica Leone. Le secteur de l'éclairage constitue l'activité principale de Luta Bettonica, qui avec Cini&Nils, a réalisé des produits à haut profil innovateur qui sont le résultat d'intenses recherches et expérimentations sur la lumière et les technologies.

Luta Bettonica se diploma en Diseño industrial en el Instituto Europeo de Diseño y en 1991 inicia su carrera como profesional liberal en el campo del diseño. Franco Bettonica y Mario Melocchi son sus primeros interlocutores proyectivos y en 1996, con el arquitecto Giancarlo Leone, funda en Milán el estudio de arquitectura y diseño Bettonica Leone. Su actividad se centra en el sector luminotécnico y, junto con Cini&Nils, ha creado productos altamente innovadores que son el resultado de una intensa investigación y experimentación en el ámbito de la luz y las tecnologías.



Giancarlo Leone

Giancarlo Leone, architetto, nasce a Catania e si laurea al Politecnico di Milano. Inizia a lavorare tra Catania e Milano con lo studio di famiglia "studio Architetti Leone" redigendo i Piani Regolatori Generali di alcuni Comuni Etnei. A Milano si occupa di ristrutturazioni, restauro ed allestimenti. Nel 1996 incontra Luta Bettonica in occasione dei progetti per il Centro Culturale Roberto Baggio a Thiene ed il Ristorante Fandango a Milano.

Giancarlo Leone is an architect, a native of Catania who graduated from Milan Polytechnic, after which he started working in both Catania and Milan with the family architecture office "studio Architetti Leone", drawing up the General Master Plans for several municipalities in the area around Mount Etna, in Sicily. In Milan, he focused on projects of refurbishment, restoration and installation. He met Luta Bettonica in 1996 on the occasion of the projects for the Roberto Baggio Culture Centre in Thiene and the restaurant Fandango in Milan.

Giancarlo Leone, Architekt, wurde im sizilianischen Catania geboren und machte seinen Hochschulabschluss am Mailänder Polytechnikum. Er begann in Catania und Mailand im Architektenbüro seiner Familie "Studio Architetti Leone" zu arbeiten und erstellte u. a. die Flächennutzungspläne mehrerer Gemeinden am Ätna. In Mailand betreute er Sanierungs- und Restaurierungsbauprojekte sowie Raumausstattungen. 1996 lernte er Luta Bettonica bei den Entwurfsarbeiten für das Kulturzentrum Roberto Baggio in Thiene und das Restaurant Fandango in Mailand kennen.

Giancarlo Leone, architecte, est né à Catane et est diplômé de l'Ecole Polytechnique de Milan. Il commence à travailler entre Catane et Milan auprès du cabinet de famille "Studio Architetti Leone", en élaborant les Plans Régulateurs Généraux de certaines Communes de l'Etna. À Milan, il s'occupe de rénovation, restauration et aménagement. En 1996, il rencontre Luta Bettonica à l'occasion des projets pour le Centre Culturel Roberto Baggio à Thiene et pour le Restaurant Fandango de Milan.

Giancarlo Leone nace en Catania y se gradúa en arquitectura en el Politécnico de Milán. Comienza su carrera como arquitecto entre Catania y Milán con el estudio familiar Studio Architetti Leone, elaborando los Planes Generales de Ordenación Urbana de varios municipios etneos. En Milán se ocupa de reestructuraciones, restauraciones y acondicionamientos. En 1996 conoce a Luta Bettonica con motivo de los proyectos del Centro Cultural Roberto Baggio en Thiene y del Restaurante Fandango en Milán.

Conservative restoration Cascina Guardia di Sopra. Corsico, Milan, Italy.



photo Nancy Fina





photo Delfino Sisto Legnani

Sarca 235, office building in Viale Sarca, Milan, Italy.

Alessandro Scandurra

Alessandro Scandurra fonda Scandurra Studio Architettura - SSA nel 2001 a Milano. Progettista in Italia e all'estero, ha realizzato sedi di aziende come Philips Italia e Zurich Insurance Italia, il primo Smart District d'Italia a Milano, spazi per il commercio, hotels e interventi su edifici storici come il Palladio Museum di Vicenza, di cui è curatore. Si occupa di pianificazione urbana e trasformazione della città. È membro della commissione del paesaggio del Comune di Milano. Ha ricevuto nomine e menzioni per premi come la Medaglia d'Oro, il premio Mies Van Der Rohe e il Compasso d'Oro. Ha partecipato alla Biennale di Architettura di Venezia e alla Triennale di Milano. Ha insegnato presso il Politecnico di Milano, e ad oggi è visiting professor alla SUPSI, in Svizzera.

Alessandro Scandurra founded Scandurra Studio Architettura – SSA in Milan in 2001. Working in Italy and abroad, he has designed corporate offices for Philips Italy and Zurich Insurance Italy, Italy's first Smart District in Milan, commercial venues, hotels and restoration work in historical buildings, such as the Palladio Museum in Vicenza, where he is also curator. He works on urban planning and city transformation. He is a member of the City of Milan landscape committee. A recipient of nominations and mentions in such awards as the Medaglia d'Oro, the Mies Van Der Rohe Award and the Compasso d'Oro. He has taken part in the Venice Architecture Biennale and the Milan Triennale. He has lectured at Milan Polytechnic and is now visiting professor at the SUPSI, in Switzerland.

Alessandro Scandurra gründete 2001 in Mailand das Architektenbüro Scandurra Studio Architettura (SSA). Er wirkte in Italien und im Ausland und entwarf u. a. den Firmensitz von Philips Italien und der Zurich Insurance Group Italien, den ersten „Smart District“ Italiens in Mailand, Ladengeschäfte und Hotels. Er betreute zudem Restaurierungsarbeiten an historischen Gebäuden wie dem Palladio-Museum in Vicenza, dessen Kurator er auch ist. Er beschäftigt sich mit Städteplanung und Stadtentwicklung und ist Mitglied in der Raumplanungskommission der Stadt Mailand. Er wurde mit zahlreichen Nominierungen und Erwähnungen bei Wettbewerben wie der Medaglia d'Oro, dem Mies-van-der-Rohe-Preis und dem Compasso d'Oro geehrt. Er hat an der Architekturbieniale in Venedig und an der Mailänder Triennale teilgenommen. Er unterrichtete am Mailänder Polytechnikum und ist bis heute Gastprofessor an der Fachhochschule SUPSI im Schweizer Tessin.

Alessandro Scandurra a fondé le Scandurra Studio Architettura - SSA en 2001 à Milan. Designer en Italie et à l'étranger, il a réalisé des sièges de sociétés telles que Philips Italia et Zurich Insurance Italia, le premier Smart District d'Italie à Milan, des centres commerciaux, des hôtels et des interventions sur des bâtiments historiques tels que le musée Palladio de Vicence, dont il est conservateur. Il s'occupe de l'aménagement urbain et de la transformation de la ville. Il est membre de la Commission du Paysage de la Municipalité de Milan. Il a reçu des nominations et des mentions pour des prix tels que la Medaglia d'Oro, le prix Mies Van Der Rohe et le Compasso d'Oro. Il a participé à la Biennale d'Architecture de Venise et à la Triennale de Milan. Il a enseigné à l'École Polytechnique de Milan et est aujourd'hui visiting professor à la SUPSI, en Suisse.

Alessandro Scandurra funda el Scandurra Studio Architettura - SSA en el año 2001 en Milán. Proyectista en Italia y en el extranjero, ha realizado sedes de compañías como Philips Italia y Zurich Insurance Italia, el primer Smart District de Italia en Milán, espacios para el comercio, hoteles y varias intervenciones en edificios históricos como el Museo Palladio en Vicenza del que es curador. Se dedica a la planificación urbana y a la transformación de la ciudad. Es miembro de la Comisión de paisaje del ayuntamiento de Milán. Ha recibido nominaciones y menciones para premios como la Medalla de Oro, el premio Mies Van Der Rohe y el Compás de oro. Ha participado en la Bienal de Arquitectura de Venecia y en la Trienal de Milán. Ha impartido clases en el Politécnico de Milán y actualmente es profesor visitante en la SUPSI (Universidad de Ciencias aplicadas y artes) de Suiza.

Collections



Flip
p. 20



Sottile
p. 36



Indice
p. 58



Flip
p. 20



Sferico
p. 86



TensoStilo
p. 236



TensoSpot
p. 244



Roma
p. 82



Fludd
p. 90



Incontro
p. 154



Fludd
p. 90



Stilo sospeso
p. 96



newTensoled
p. 248



TensoFari
p. 252

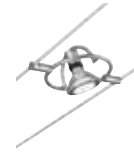

Assolo
p. 162



Assolo
p. 170



Assolo outdoor
p. 176



Acqua
p. 102



Passepartout25
p. 118



newTensoGradi
p. 258



miniTensoSferico
p. 262



FormaLa
p. 180



Sestessa
p. 200



Gradi
p. 206



Passepartout55
p. 124



Assolo
p. 162



miniTensoOnirico
p. 268



miniTensoFari
p. 272



Componi200
p. 222



Componi75
p. 230



Fari
p. 282



Sestessa
p. 200



Convivio
p. 216



TensoEsterni
p. 276



miniFari
p. 286



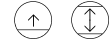

Flip
p. 20



Sottile
p. 36



Fischietto
p. 44



Manhattanhenge
p. 66



Ognidove
p. 72



Ognidove
p. 78



Acquafilo
p. 102



Anda
p. 50



Roma
p. 82



Passepartout
p. 112



Bouquet
p. 138



Cuboluce
p. 146



Passepartout
p. 132



Assolo
p. 162



Incontro
p. 154



Assolo
p. 170



Assolo outdoor
p. 176



Assolo
p. 170



Componi200
p. 222



Sestessa
p. 196



Gradi
p. 206



FormaLa
p. 180



Sestessa
p. 190



Gradi
p. 206



Componi200
p. 222



Componi200
p. 222



Componi75
p. 230



Fari
p. 282



miniFari
p. 286



Design | Interni

Flip

2023



Flip è una linea di prodotti che si distingue per la sua versatilità e il design avveniristico. La peculiarità distintiva di Flip è la sua cupola inclinabile che permette di sperimentare un'illuminazione personalizzata in tre diverse modalità: sospesa, a plafone o come applique da parete. È disponibile in 3 dimensioni e 10 varianti colore, studiate appositamente per integrarsi armoniosamente a qualsiasi stile di arredamento. Grazie all'effetto di illuminazione diffusa creato, Flip regala un'esperienza audace e una qualità senza precedenti.

Flip is a product line that stands out for its versatility and futuristic design. Flip's distinctive feature is its tilting dome that allows customised ambient lighting in three different modes: suspended, surface mounted or as a wall light. It is available in 3 sizes and 10 colour variants, designed to blend harmoniously into any furnishing style. Thanks to the diffuse lighting effect created, Flip delivers a bold experience and unprecedented quality.

Flip ist eine Produktlinie, die sich durch ihre Vielseitigkeit und ihr futuristisches Design auszeichnet. Die Besonderheit von Flip ist die schwenkbare Kuppel, die eine individuelle Beleuchtung in drei verschiedenen Modi ermöglicht: abgependelt, aufgesetzt oder als Wandleuchte. Sie ist in 3 Größen und 10 Farbvarianten erhältlich, die sich harmonisch in jeden Einrichtungsstil einfügen. Dank des diffusen Lichteffekts, den sie erzeugt, bietet Flip ein kühnes Erlebnis und eine noch nie dagewesene Qualität.

Flip est une ligne de produits qui se distingue par sa polyvalence et son design futuriste. La caractéristique distinctive de Flip est son dôme inclinable qui permet de personnaliser l'éclairage selon trois modes différents: suspendu, en surface ou comme applique murale. Elle est disponible en 3 tailles et 10 variantes de couleurs, conçues pour s'intégrer harmonieusement à tous les styles d'ameublement. Grâce à l'effet d'éclairage diffus créé, Flip offre une expérience audacieuse et une qualité sans précédent.

Flip es una línea de productos que destaca por su versatilidad y diseño futurista. La característica distintiva de Flip es su cúpula basculante que permite una iluminación personalizada en tres modos diferentes: suspendida, de superficie o como aplique. Está disponible en 3 tamaños y 10 variantes de color, diseñadas para integrarse armoniosamente en cualquier estilo de decoración. Gracias al efecto de iluminación difusa que crea, Flip ofrece una experiencia audaz y una calidad sin precedentes.

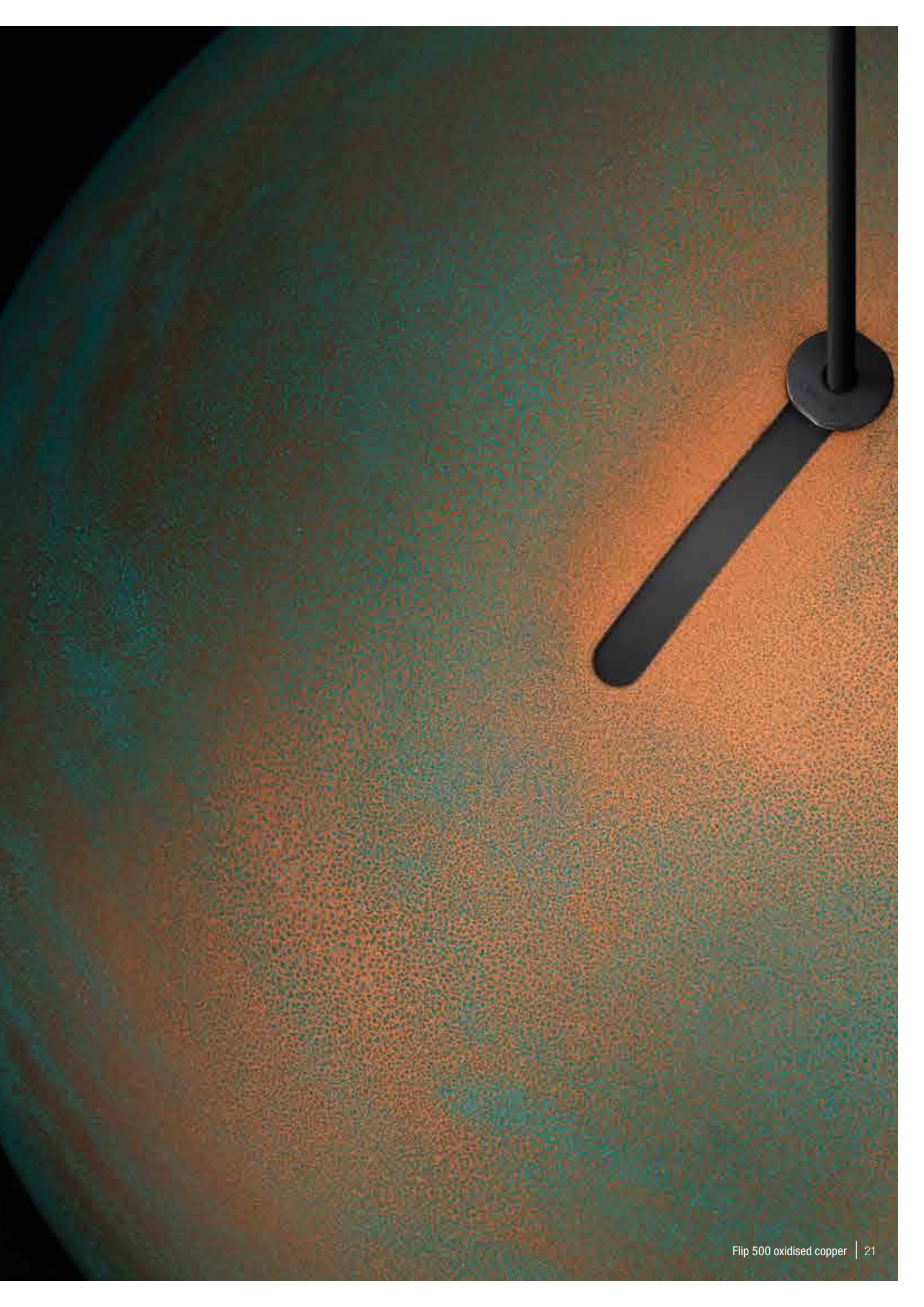























Flip 500 plafone | parete black-gold

Example of configuration

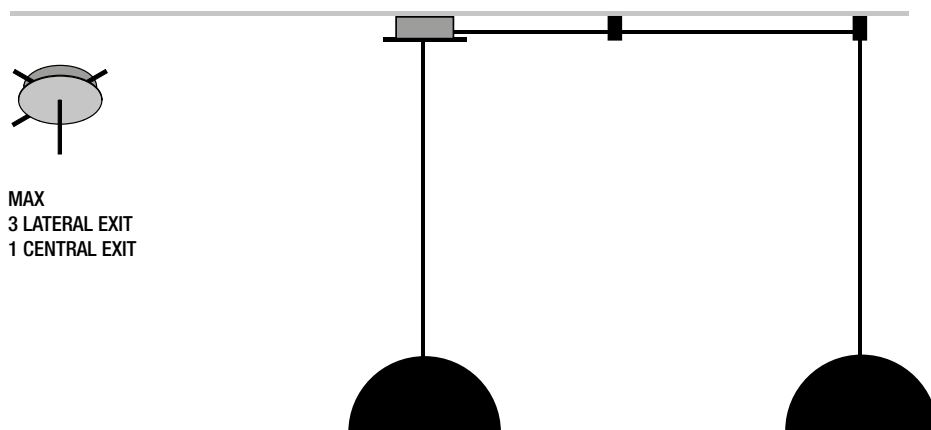
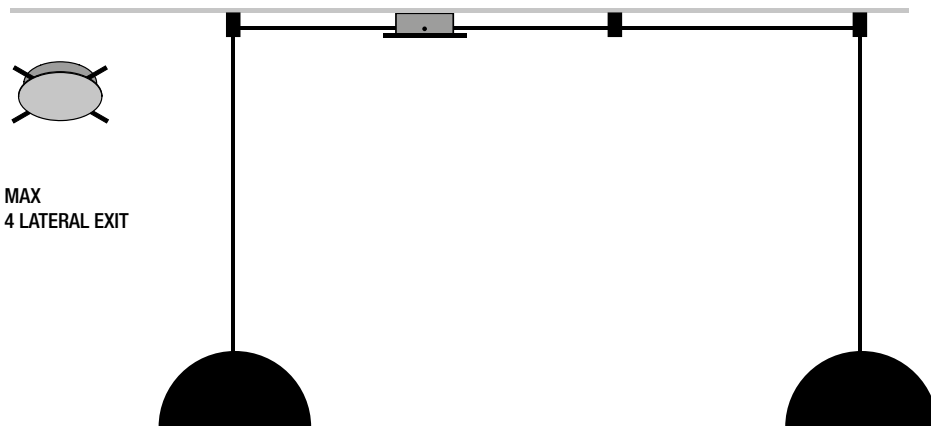

Flippino

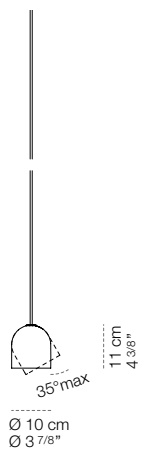

CAVO 4M

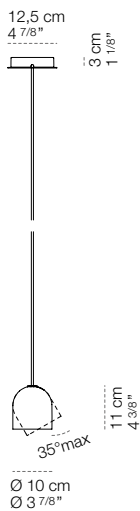

ROSONE + CAVO 4M

Flip 250

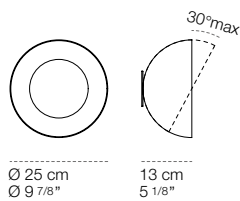

PLAFONE I PARETE

Flip 250

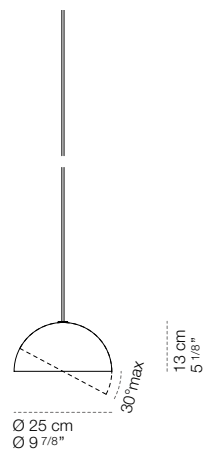

SOSPESO CON CAVO 4M

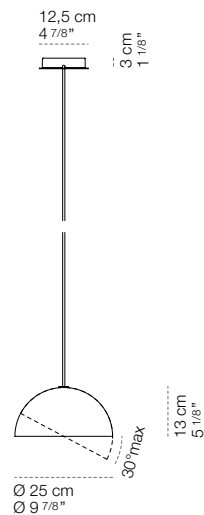

SOSPESO CON ROSONE + CAVO 4M

Flip 500

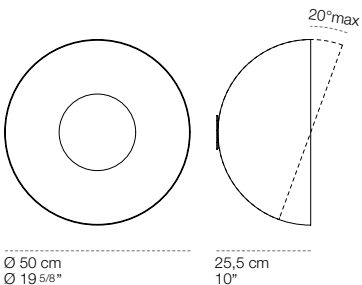

PLAFONE I PARETE

Flip 500

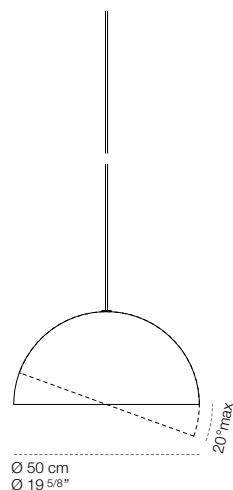

SOSPESO CON CAVO 4M

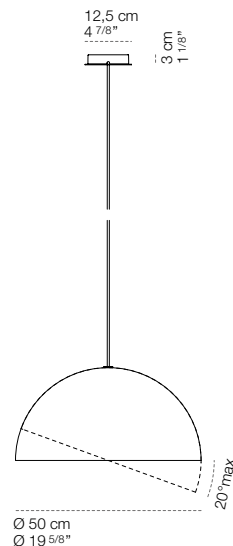

SOSPESO CON ROSONE + CAVO 4M

Flip

2023



-  bianco / white / weiß / blanc / blanco RAL 9003
-  nero / black / schwarz / noir / negro - RAL 9005
-  azzurro / light blue / hellblau / bleu clair / azul claro - RAL 7000
-  ocre / ochre / ockerfarben / ocre / ocre - RAL 8004
-  verde / green / grün / vert / verde - RAL 6013
-  grigio / grey / grau / gris / gris RAL 7030
-  bianco-oro rosa / white-rosegold / weiß-Roségold
blanc-or / rose - blanco-oro rosado
-  nero-oro / black-gold / schwarz-Gold / noir-or / negro-oro
-  rame martellato / hammered copper / Hammerschlagkupfer
cuivre martelé / cobre martillado
-  rame ossidato (*solo su richiesta*) / oxidised copper (*only on request*)
oxidiertes Kupfer (*nur auf Anfrage*) / cuivre oxydé (*seulement sur demande*)
cobre oxidado (*sólo bajo petición*)

light emission available:

FLIPPINO

led E14 / 4W / 470 lm / 2.700K - 3.000K - 4.000K (bulb included)

FLIP 250

led 10W / 1.200 lm / 2.700K - 3.000K - 4.000K

FLIP 500

led 20W / 2.400 lm / 2.700K - 3.000K - 4.000K

Accessories

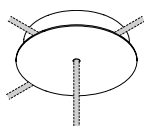

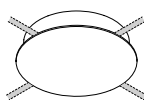

ROSONE CON FORO CENTRALE

Colour:  



ROSONE CON FORI LATERALI

Colour:  



DECENTRATORE

Colour: 

Design | Interni

Sottile

2025



Sottile, l'applique da parete e soffitto che illumina la casa con stile. Con soli 8mm di spessore e un corpo in alluminio fresato, Sottile è la soluzione perfetta per chi cerca un design minimal senza rinunciare alla qualità della luce. L'ottica progettata garantisce performance luminose efficienti grazie a una distribuzione indiretta e asimmetrica della luce, creando un'atmosfera calda e accogliente. Con 6 raffinate colorazioni a disposizione, Sottile aggiunge un tocco di classe ad ogni ambiente. È disponibile in due diverse dimensioni per soddisfare tutte le esigenze di spazio.

Sottile, the wall and ceiling light that illuminates the home with style. With a thickness of only 8 mm and a milled aluminium body, Sottile is the perfect solution for those looking for a minimalist design without compromising on the quality of light. The engineered optics ensure efficient lighting performance through indirect and asymmetric light distribution, creating a warm and welcoming atmosphere. With 6 refined colours available, Sottile adds a touch of class to any environment. It is available in two different sizes to suit all space requirements.

Sottile, die Wand- und Deckenleuchte, die Ihr Zuhause stilvoll beleuchtet. Mit einer Dicke von nur 8 mm und einem gefrästen Aluminiumkörper ist Sottile die perfekte Lösung für alle, die ein minimalistisches Design suchen, ohne Kompromisse bei der Lichtqualität einzugehen. Die entworfene Optik garantiert eine effiziente Lichtleistung durch eine indirekte und asymmetrische Lichtverteilung und schafft so eine warme und einladende Atmosphäre. Mit sechs verfügbaren raffinierten Farben verleiht Sottile jedem Ambiente einen Hauch von Klasse. Sie ist in zwei verschiedenen Größen erhältlich, um allen Raumbedürfnissen gerecht zu werden.

Sottile, l'applique et le plafonnier qui illuminent la maison avec style. Avec une épaisseur de seulement 8 mm et un corps en aluminium fraisé, Sottile est la solution parfaite pour ceux qui recherchent un design minimaliste sans faire de compromis sur la qualité de la lumière. L'optique conçue garantit une performance d'éclairage efficace grâce à une distribution indirecte et asymétrique de la lumière, créant ainsi une atmosphère chaleureuse et accueillante. Avec 6 couleurs raffinées disponibles, Sottile ajoute une touche de classe à n'importe quelle ambiance. Il est disponible en deux tailles différentes pour répondre à toutes les exigences d'espace.

Sottile, el aplique y plafón que ilumina el hogar con estilo. Con un grosor de sólo 8 mm y un cuerpo de aluminio fresado, Sottile es la solución perfecta para quienes buscan un diseño minimalista sin renunciar a la calidad de la luz. La óptica de diseño garantiza una iluminación eficaz gracias a la distribución indirecta y asimétrica de la luz, creando un ambiente cálido y acogedor. Con 6 refinados colores disponibles, Sottile añade un toque de clase a cualquier ambiente. Está disponible en dos tamaños diferentes para adaptarse a todas las necesidades de espacio. tamaños diferentes para adaptarse a todas las necesidades de espacio.





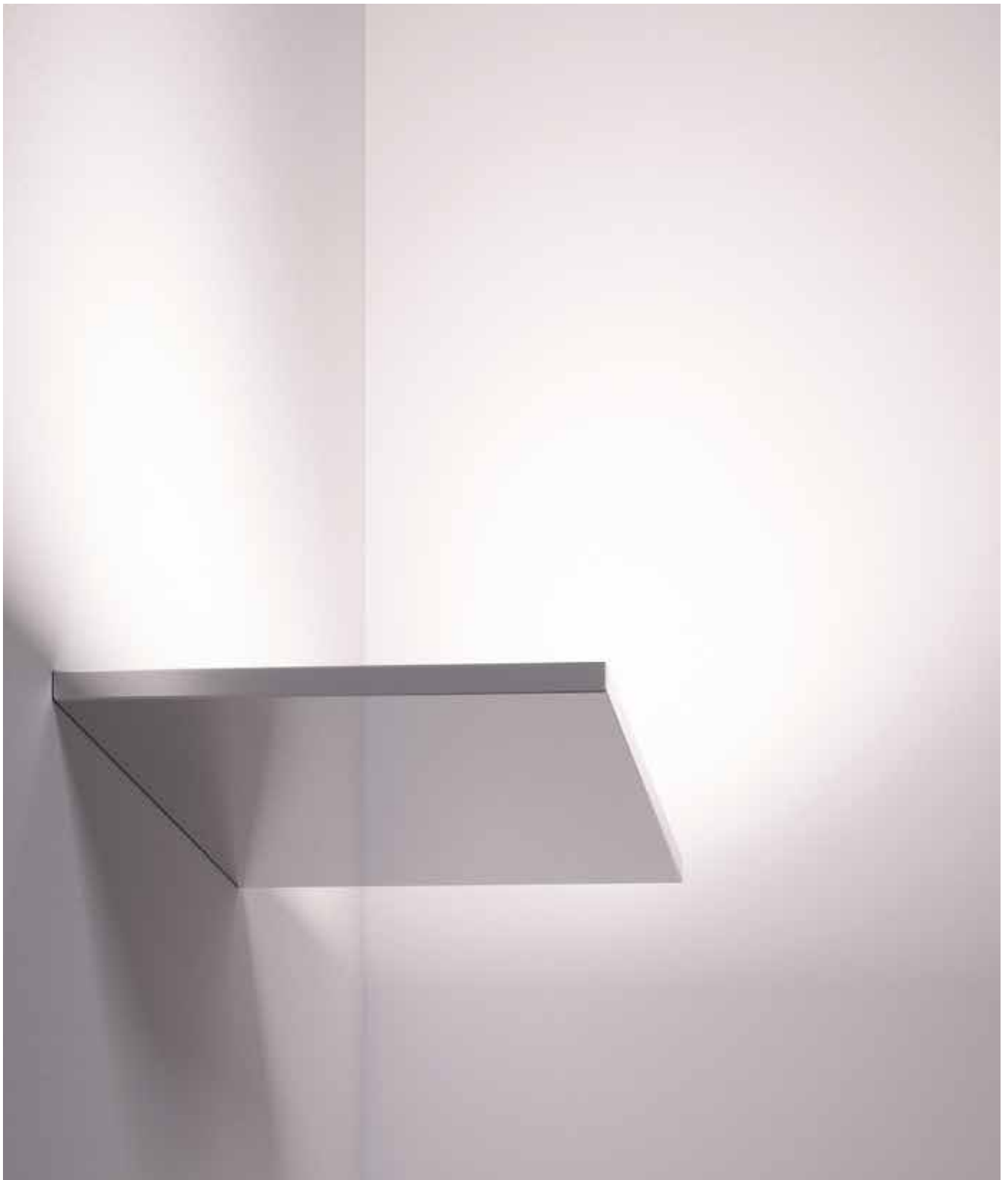





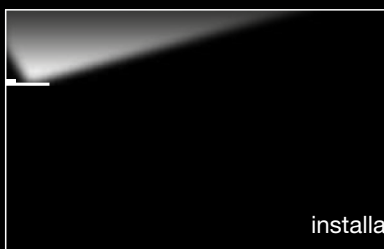

installazione a parete

wall installation / Wandeinbau
installation au mur / instalación en pared

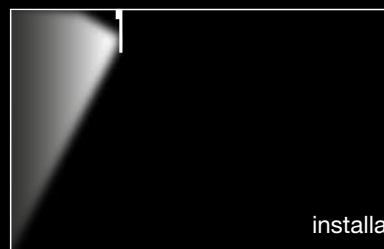

installazione a soffitto

ceiling installation / Deckeneinbau
installation du plafond / instalación en techo

Sottile

2023



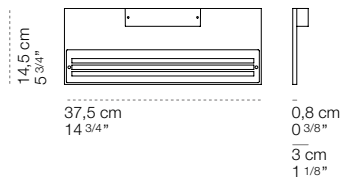

Sottile 380

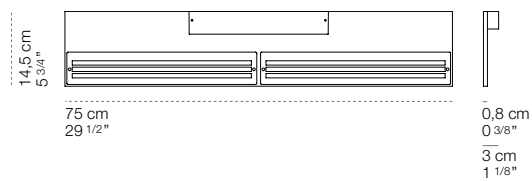

Sottile 750





 bianco / white / weiß / blanc / blanco

 nero / black / schwarz / noir / negro

 oro / gold / Gold / or / oro

 oro rosa / rosegold / Roségold / or rose / oro rosado

 oro lucido / polished gold / glanzpoliertes Gold
or brillant / oro brillante

 cromo lucido / polished chrome / glanzverchromt
chrome brillant / cromo brillante

light control available:

 phase cut dimmable

Solid aluminium body , moulded ABS BOX , stainless steel mounting bracket, PMMA reflector.

light emission available:

luce indiretta e asimmetrica / indirect and asymmetrical light
/ indirektes und asymmetrisches Licht / lumière indirecte et
asymétrique / luz indirecta y asimétrica

SOTTILE 380

led 25W / 2.000 lm / 2.700K - 3.000K - 4.000K / CRI90

SOTTILE 750

led 50W / 4.000 lm / 2.700K - 3.000K - 4.000K / CRI90

Design | Interni

Fischietto

2023



Fischietto è una lampada da lettura fuori dall'ordinario: incorpora una presa USB-C e due interruttori, il tutto in un design senza pari. Perfetta per gli spazi notturni o le zone di studio, Fischietto presenta un faretto orientabile con illuminazione dimmerabile. I due interruttori presenti controllano l'accensione sia del faretto spot che dell'illuminazione generale dell'ambiente. Con la possibilità di scegliere tra diverse opzioni di colore per la placca frontale, Fischietto si adatta ad ogni stile. Benvenuti nella nuova era dell'illuminazione multitasking.

Fischietto is an out of the ordinary reading lamp: it incorporates a USB-C socket and two switches, all in an unparalleled design. Perfect for night spaces or study areas, Fischietto features a swivelling spotlight with dimmable lighting. Its two switches control the turning on of both the spotlight and the general ambient lighting. With a choice of different colour options for the front plate, Fischietto fits every style. Welcome to the new era of multitasking lighting.

Fischietto ist eine außergewöhnliche Leselampe: Sie verfügt über eine USB-C-Buchse und zwei Schalter in einem unvergleichlichen Design. Fischietto eignet sich perfekt für Nachträume oder Arbeitszimmer und verfügt über einen schwenkbaren Strahler mit dimmbarer Beleuchtung. Mit zwei Schaltern lassen sich sowohl der Strahler als auch die allgemeine Raumbeleuchtung schalten. Mit einer Auswahl an verschiedenen Farboptionen für die Frontplatte passt Fischietto zu jedem Stil. Willkommen in der neuen Ära der Multitasking-Beleuchtung.

Fischietto est une lampe de lecture hors du commun: elle intègre une prise USB-C et deux interrupteurs, le tout dans un design inégalé. Parfaite pour les espaces nocturnes ou les zones d'étude, Fischietto est dotée d'un spot orientable à l'éclairage variable. Ses deux interrupteurs permettent de commander à la fois le spot et l'éclairage ambiant général. Avec un choix de différentes couleurs pour la plaque frontale, Fischietto s'adapte à tous les styles. Bienvenue dans la nouvelle ère de l'éclairage multitâche.

Fischietto es una lámpara de lectura fuera de lo común: incorpora una toma USB-C y dos interruptores, todo ello en un diseño sin igual. Perfecta para espacios nocturnos o zonas de estudio, Fischietto incorpora un foco orientable con iluminación regulable. Sus dos interruptores controlan el encendido tanto del foco como de la iluminación ambiental general. Con una selección de diferentes opciones de color para la placa frontal, Fischietto se adapta a todos los estilos. Bienvenido a la nueva era de la iluminación multitarea.









Piccola mensola testata letto dotata di presa USB-C (8W) e due interruttori. Fischietto risulta la soluzione ideale per il segmento hôtellerie anche grazie alla possibilità di personalizzazione della cover frontale.

Small bedhead shelf with USB-C socket (8W) and two switches. Fischietto is the ideal solution for the hôtellerie segment also thanks to the possibility of customising the front cover.

Kleine Ablage am Bettkopf mit USB-C-Buchse (8W) und zwei Schaltern. Fischietto ist die ideale Lösung für das Hôtellerie-Segment, auch dank der Möglichkeit, die Frontplatte individuell zu personalisieren.

Petite tablette de tête de lit avec prise USB-C (8W) et deux interrupteurs. Fischietto est la solution idéale pour le segment de l'hôtellerie grâce aussi à la possibilité de personnaliser la plaque frontale.

Pequeño estante de cabecero de cama con toma USB-C (8W) y dos interruptores. Fischietto es la solución ideal para el segmento de la hôtellerie también gracias a la posibilidad de personalizar la placa frontal.

Fischietto

2023



Fischietto R

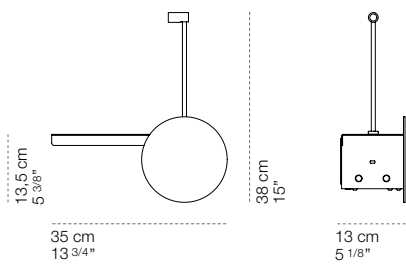

bianco / white / weiß / blanc / blanco



nero / black / schwarz / noir / negro



nero-oro / black-gold / schwarz-Gold / noir-or / negro-oro



nero-argento / black-silver / schwarz-Silber / noir-argent / negro-platead



nero-oro rosa / black-rosegold / schwarz-Roségold
noir-or rose / negro-oro rosado

Fischietto L

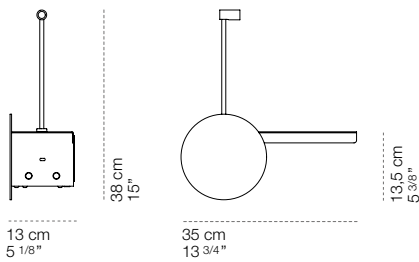

light control available:

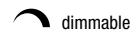

dimnable

light emission available:

luce diretta localizzata / localised direct light /
lokalisieretes direktes Licht / lumière directe localisée /
luz directa localizada

led 1,5W / 300 lm / 2.700K / CRI90

Design | Interni

Anda

2025



Anda unisce un design moderno e slim a un'illuminazione diffusa. Si presenta come una soluzione compatta, perfetta sia come segnapasso per interni che come applique, consentendo la creazione di composizioni d'arredo versatili.

Entrambi i modelli, Anda e Anda Full, hanno un'estetica uniforme e moderna. Disponibile nelle finiture bianco, nero, oro, argento e nelle affascinanti versioni bicolore nero-oro e nero-oro rosa. È possibile montare il prodotto senza la piastra retrostante, consentendo di esaltare pareti o carte da parati con un effetto d'illuminazione straordinario.

Anda combines a modern, slim design with diffuse lighting. It presents itself as a compact solution, perfect both as an indoor steplight and as a wall light, allowing the creation of versatile furnishing compositions.

Both models, Anda and Anda Full, have a uniform, modern aesthetic. Available in white, black, gold, silver and in the attractive two-tone black-gold and black-rosegold versions. The product can be mounted without the back plate, allowing it to enhance walls or wallpapers with an extraordinary lighting effect.

Anda kombiniert ein modernes, schlankes Design mit diffuser Beleuchtung. Sie präsentiert sich als kompakte Lösung, die sich sowohl als Stufenleuchte als auch als Wandleuchte eignet und die Schaffung vielseitiger Einrichtungskompositionen ermöglicht. Beide Modelle, Anda und Anda Full, haben eine einheitliche, moderne Ästhetik. Sie sind in den Farben Weiß, Schwarz, Gold, Silber und in den attraktiven zweifarbigen Versionen Schwarz-Gold und Schwarz-Roségold erhältlich. Das Produkt kann ohne Rückplatte montiert werden, so dass es Wände oder Tapeten mit einem außergewöhnlichen Lichteffect aufwerten kann.

Anda combine un design moderne et fin avec un éclairage diffus. Elle se présente comme une solution compacte, parfaite à la fois comme steplight d'intérieur et comme applique murale, permettant de créer des compositions d'ameublement polyvalentes. Les deux modèles, Anda et Anda Full, ont une esthétique uniforme et moderne. Ils sont disponibles en blanc, noir, or, argent et dans les séduisantes versions bicolores noir-or et noir-or rose. Le produit peut être monté sans la plaque arrière, ce qui permet de mettre en valeur les murs ou les papiers peints avec un effet lumineux extraordinaire.

Anda combina un diseño moderno y slim con una iluminación difusa. Se presenta como una solución compacta, perfecta tanto como señalizador de interior como aplique de pared, permitiendo crear composiciones de mobiliario versátiles. Ambos modelos, Anda y Anda Full, presentan una estética uniforme y moderna. Disponibles en blanco, negro, oro, plata y en las atractivas versiones bicolore negro-oro y negro-oro rosado. El producto puede montarse sin la placa posterior, lo que permite realzar paredes o papeles pintados con un extraordinario efecto luminoso.





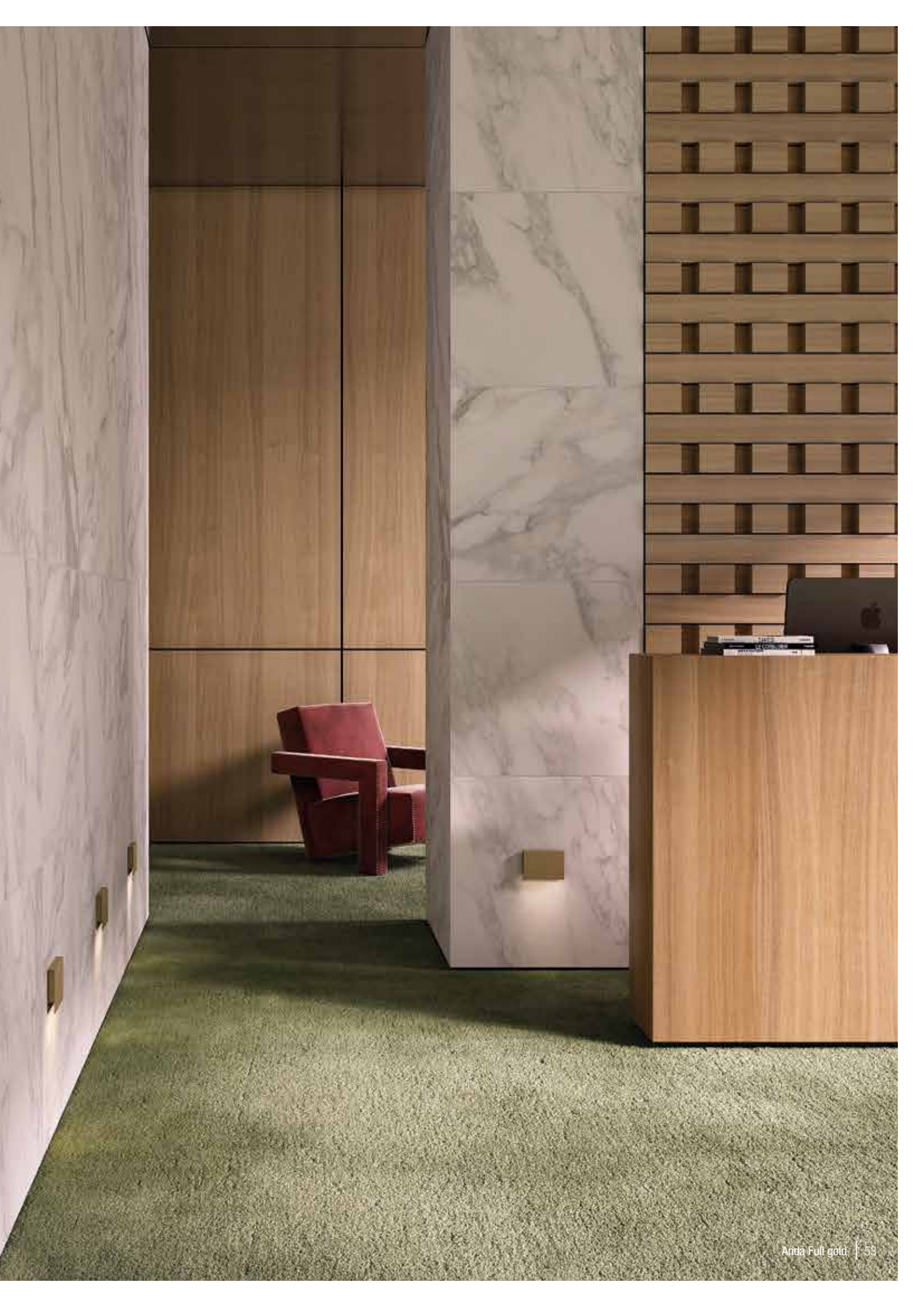



Anda può essere installato senza la piastra retrostante in modo da valorizzare pareti e carte da parati con un elegante effetto d'illuminazione.

Anda can be installed without the back plate to enhance walls and wallpapers with an elegant lighting effect.

Anda kann auch ohne die Rückplatte installiert werden, um Wände und Tapeten mit einem eleganten Lichteffect zu versehen.

Anda peut être installé sans la plaque arrière pour rehausser les murs et les papiers peints d'un élégant effet de lumière.

Anda puede instalarse sin la placa posterior para realzar paredes y papeles pintados con un elegante efecto luminoso.





Anda black-rosegold

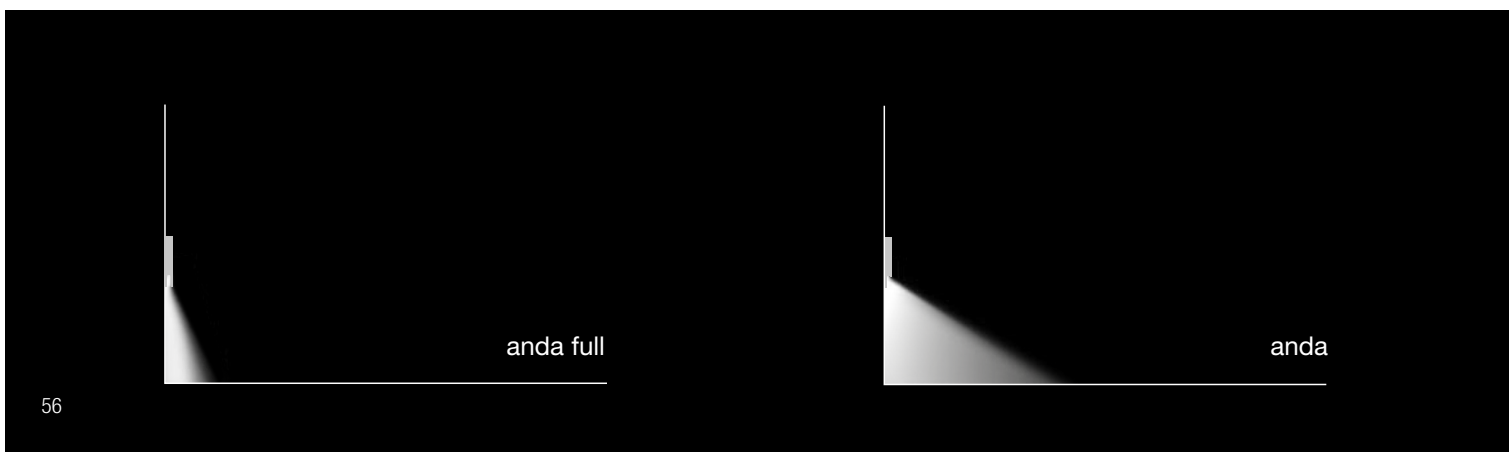

anda full

anda

Anda

2023



Anda



11,5 cm
4 1/2"

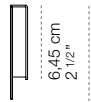

1,5 cm
0 5/8"

6,45 cm
2 1/2"
8,15 cm
3 1/4"

Anda Full



11,5 cm
4 1/2"

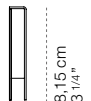

1,5 cm
0 5/8"

8,15 cm
3 1/4"



bianco / white / weiß / blanc / blanco



nero / black / schwarz / noir / negro



oro / gold / Gold / or / oro



argento / silver / Silber / argent / plateado



nero-oro / black-gold / schwarz-Gold
noir-or / negro-oro



nero-oro rosa / black-rosegold / schwarz-Roségold
noir-or rose / negro-oro rosado

light control available:



phase cut dimmable

led AC-Direct
suitable for mounting on standard boxes 502 and 503
can be installed without the back plate

light emission available:

ANDA
led 2W / 150 lm / 2.700K - 3.000K - 4.000K

ANDA FULL
led 2W / 100 lm / 2.700K - 3.000K - 4.000K

Design | Interni

Indice

2023



Elegante faretto da incasso per controsoffittature in cartongesso, uno stile minimalista declinato in molteplici finiture perfettamente abbinabili ad ambienti indoor moderni e raffinati. Indice è disponibile tondo o quadrato, fisso e orientabile per disegnare fasci di luce diffusi e asimmetrici. Compatibile con lampadina GU10 (non inclusa).

Elegant recessed spotlight for plasterboard ceilings, a minimalist style declined in multiple finishes that can be perfectly matched to modern and refined indoor environments. Indice is available round or square, fixed or adjustable to draw diffused and asymmetrical beams of light. Compatible with GU10 bulb (not included).

Eleganter Einbaustrahler für Gipskartondecken in minimalistischem Stil, der in verschiedenen Farben erhältlich ist und sich perfekt an moderne und raffinierte Innenräume anpassen lässt. Indice ist in runder oder quadratischer Form erhältlich, feststehend oder verstellbar, um diffuse und asymmetrische Lichtkegel zu erzeugen. Kompatibel mit GU10 Glühbirne (nicht enthalten).

Élégant spot encastré pour plafonds en plaques de plâtre, un style minimaliste décliné en de multiples finitions qui s'accordent parfaitement aux environnements intérieurs modernes et raffinés. Indice est disponible rond ou carré, fixe ou réglable pour dessiner des faisceaux de lumière diffus et asymétriques. Compatible avec une ampoule GU10 (non incluse).

Elegante foco empotrable para techos de escayola, un estilo minimalista declinado en múltiples acabados que se adapta perfectamente a ambientes interiores modernos y refinados. Indice está disponible en forma redonda o cuadrada, fija o ajustable para dibujar haces de luz difusos y asimétricos. Compatible con bombilla GU10 (no incluida).

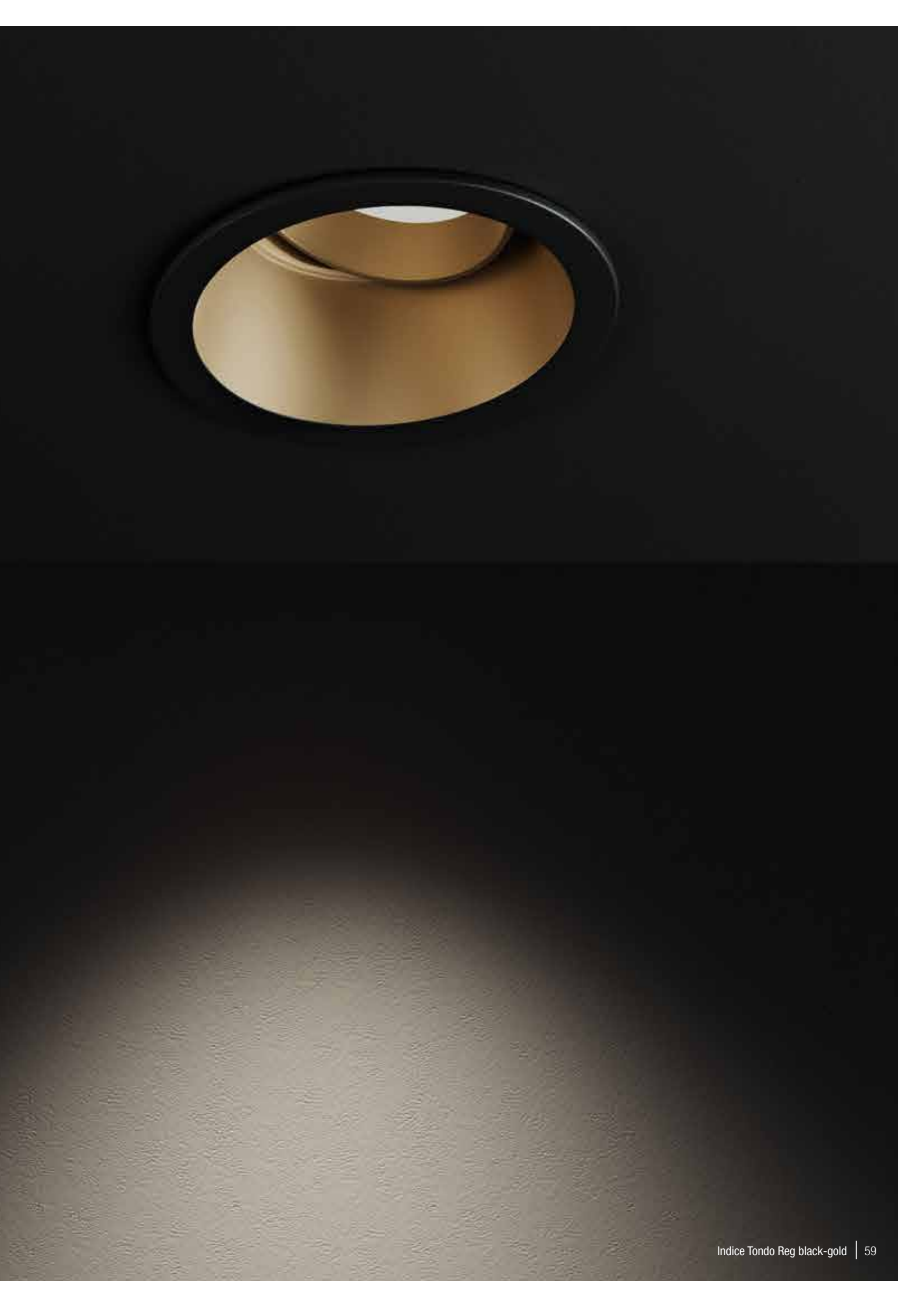









Faretto da incasso dal design essenziale in alluminio pressofuso. La verniciatura a liquido conferisce una qualità estetica superiore e protezione con uno strato anticorrosivo molto resistente. Il logo tampografato sul lato è la firma dell'eccellenza Cini&Nils.

Essential design recessed spotlight made of die-cast aluminium. Liquid coating provides superior aesthetic quality and protection with a highly resistant anti-corrosive layer. The pad-printed logo on the side is the signature of Cini&Nils excellence.

Einbaustrahler in essentiell Design aus Aluminiumdruckguss. Die Flüssigbeschichtung bietet eine hohe ästhetische Qualität und einen Schutz durch eine hochresistente Antikorrosionsschicht. Das seitlich aufgedruckte Logo ist das Markenzeichen von Cini&Nils.

Spot encastré au design essentiel en aluminium moulé sous pression. Le revêtement liquide offre une qualité esthétique et une protection supérieures grâce à une couche anticorrosive très résistante. Le logo tamponné sur le côté est la signature de l'excellence de Cini&Nils.

Foco empotrable de design esencial fabricado en aluminio fundido a presión. El revestimiento líquido proporciona una calidad estética superior y protección con una capa anticorrosiva muy resistente. El logotipo tampografiado en el lateral es la firma de la excelencia de Cini&Nils.

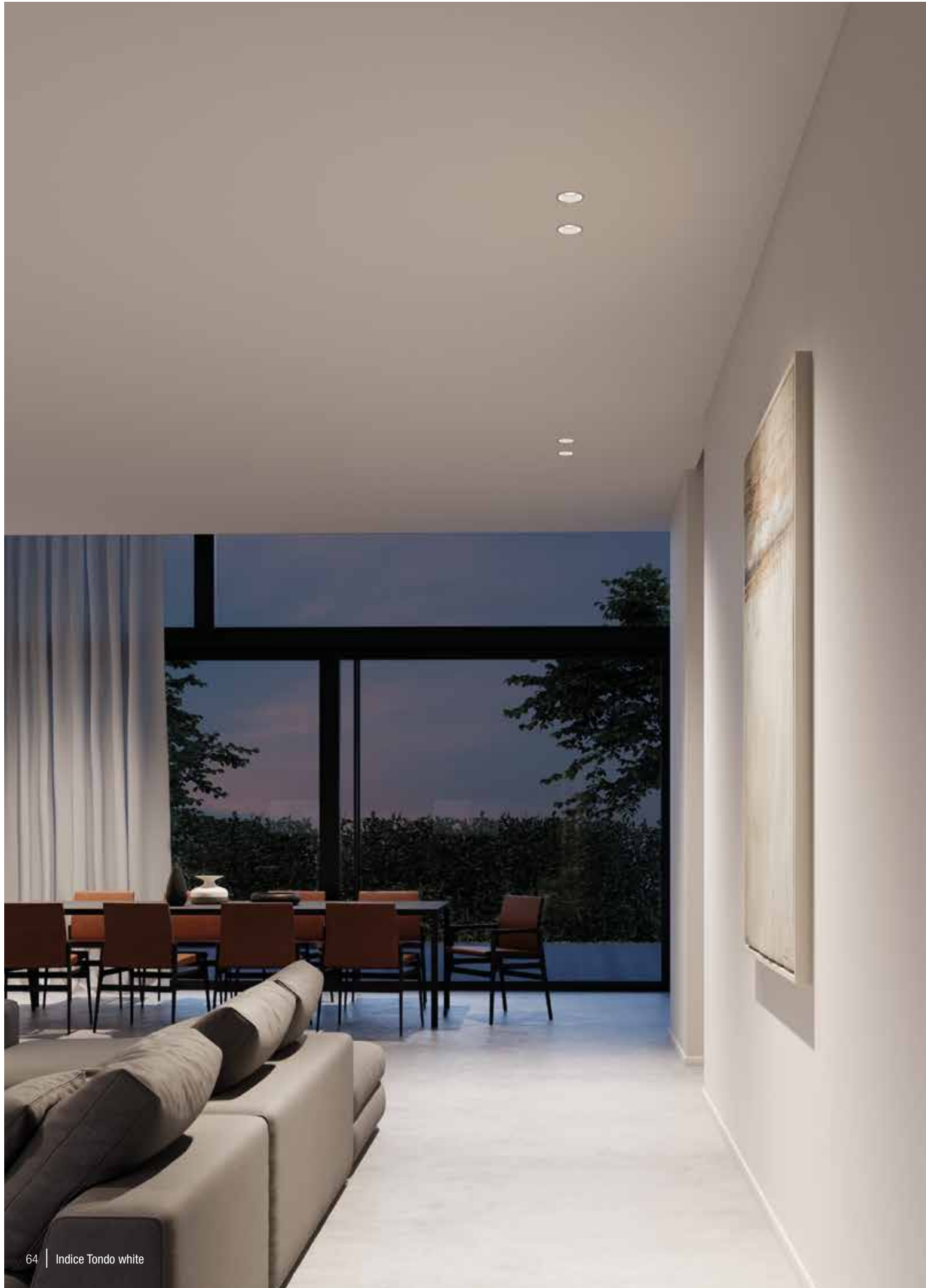

Indice

2023



Quadro

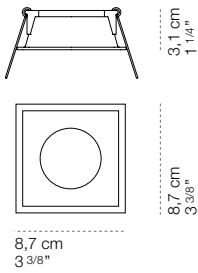

Quadro Reg

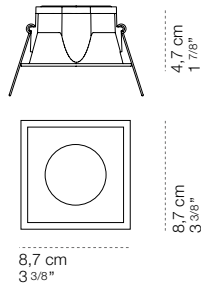

Tondo

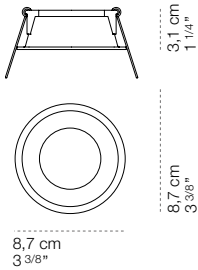

Tondo Reg

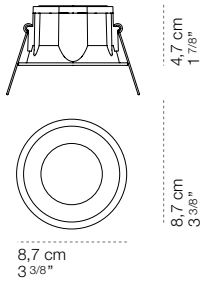

-  bianco / white / weiß / blanc / blanco
-  nero / black / schwarz / noir / negro
-  oro / gold / Gold / or / oro
-  oro rosa / rosegold / Roségold / or rose / oro rosado
-  argento / silver / Silber / argent / plateado
-  bianco-oro / white-gold / weiß-Gold
blanc-or / blanco-oro
-  bianco-oro rosa / white-rosegold
weiß-Roségold / blanc-or rose / blanco-oro rosado
-  bianco-argento / white-silver
weiß-Silber / blanc-argent / blanco-plateado
-  bianco-nero / white-black
weiß-schwarz / blanc-noir / blanco-negro
-  nero-oro / black-gold
schwarz-Gold / noir-or / negro-oro
-  nero-oro rosa / black-rosegold
schwarz-Roségold / noir-or rose / negro-oro rosado

compatible with:

GU10 (bulb not included)

plasterboard:

Ø 80 ÷ 83 mm

H min. 120 mm

Design | Interni

Manhattanhenge

Luta Bettonica, Giancarlo Leone, 2020



Lampada da appoggio per interni, dimmerabile a luce diffusa. Manhattanhenge, con due dischi arcuati in acciaio laccato opaco che accolgono la luce, coglie e restituisce la suggestione del tramonto tra i grattacieli di New York.

A freestanding luminaire for indoor installations with dimmer for diffused light. Comprising two arced discs made of matt lacquered steel that contain the light, Manhattanhenge captures and projects the suggestion of a sunset among the skyscrapers of New York City.

Steh- und Tischleuchte für den Innenbereich, die dimmbares Streulicht erzeugt. Manhattanhenge besteht aus zwei gewölbten, matt lackierten Stahlscheiben, die das Licht aufnehmen und den Eindruck eines Sonnenuntergangs zwischen den Wolkenkratzern New Yorks vermitteln.

Lampe de table d'intérieur, dimmable à lumière diffuse. Manhattanhenge, avec deux disques arqués en acier laqué mat qui captent la lumière, saisit et restitue la suggestion d'un coucher de soleil entre les gratte-ciels de New York.

Lámpara de apoyo para interiores, regulable en intensidad, de luz difusa. Manhattanhenge, con dos discos combados de acero lacado mate que acogen la luz, capta y devuelve la fascinación de una puesta de sol entre los rascacielos de Nueva York.



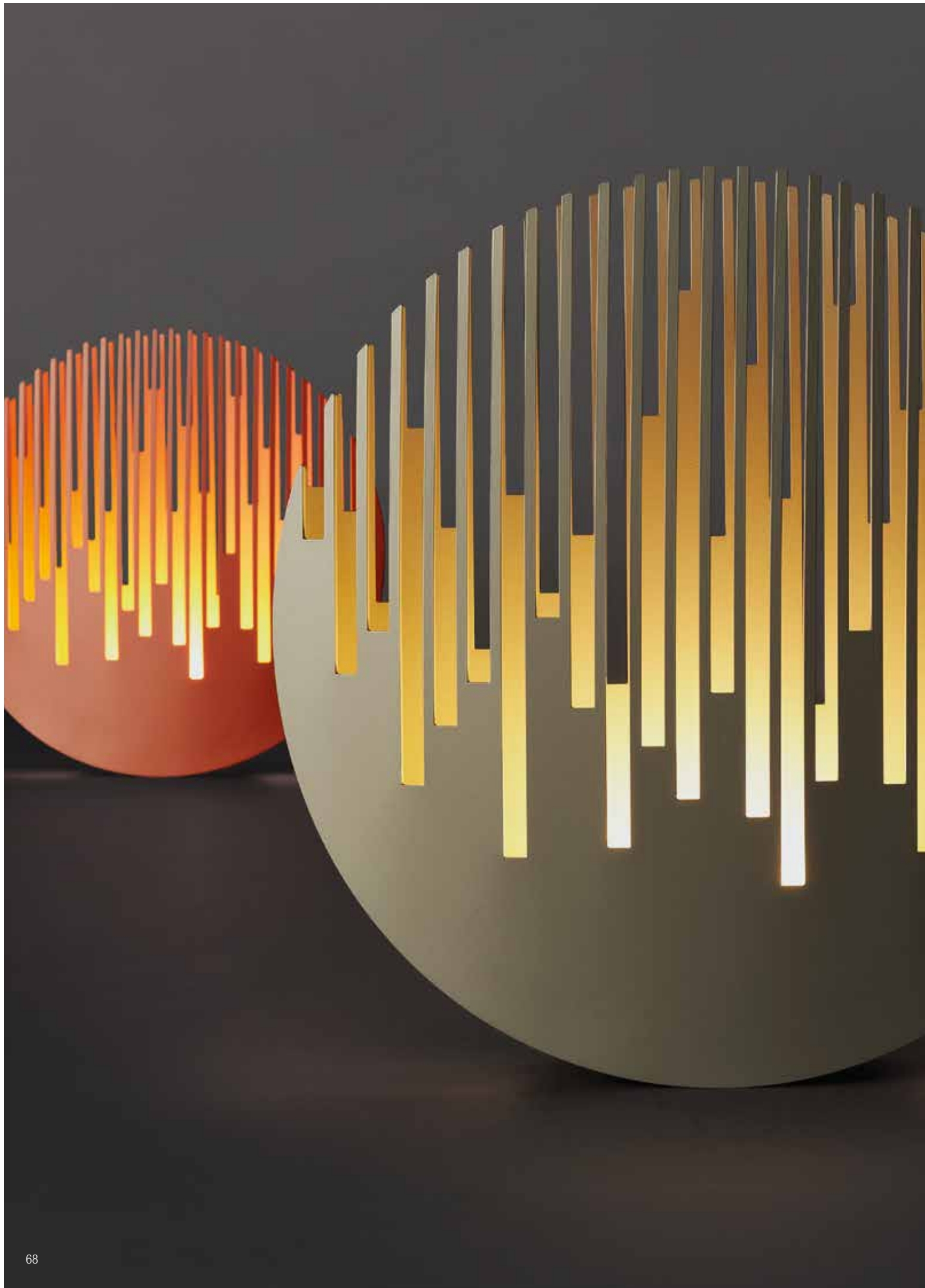

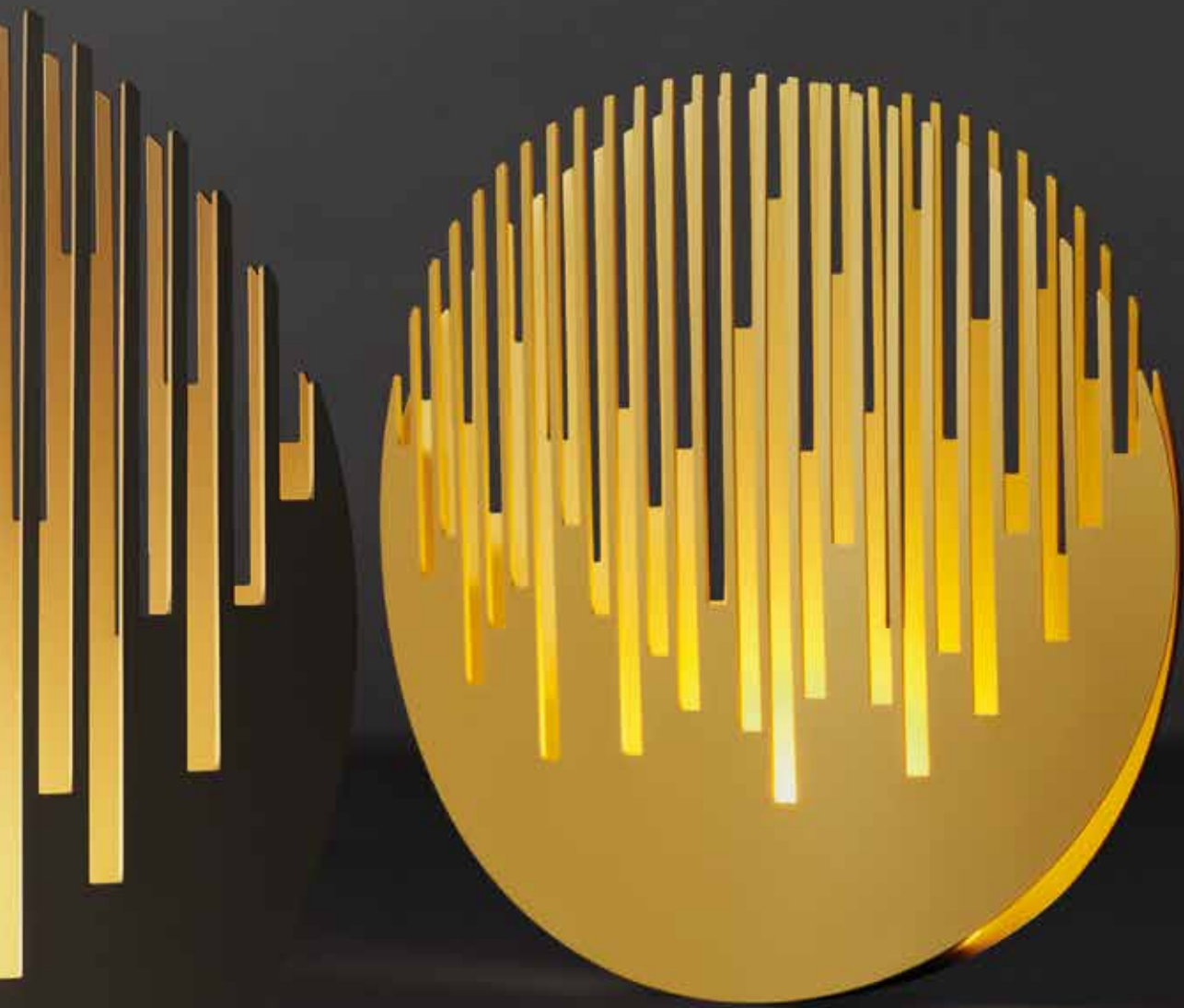



Manhattanhenge

Luta Bettonica, Giancarlo Leone, 2020

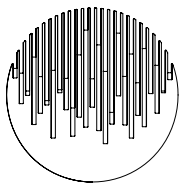

40 cm
15 3/4"



7,8 cm
2 7/8"

39,4 cm
15 1/2"



bianco / white / weiß / blanc / blanco



tortora chiaro / light dove grey / graubraun hell / taupe clair / gris pardo claro



tortora scuro / dark dove grey / graubraun dunkel / taupe foncé / gris pardo oscuro



oro / gold / Gold / or / oro



rosso / red / rot / rouge / rojo

light control available:



in line dimmer

light emission available:

luce diffusa / diffused light / diffuses Licht / lumière diffuse / luz difusa

R7s led 15W / 230V / 2.000 lm / 2.700K

Design | Interni | Esterni

Ognidove

Luta Bettonica, Giancarlo Leone, 2020



Ognidove tavolo

Luce d'atmosfera wireless con dimmer touch, per interni ed esterni, per il relax, la lettura e il centrotavola. Ognidove tavolo permette la creazione di diverse composizioni abbinando le tre finiture, con l'aggiunta di fiori e/o rami secchi. Il corpo lampada e vaso, provvisti di calamita, sono posizionabili a piacere sulla base o piani in ferro. Ognidove ha ricevuto il riconoscimento internazionale di Winner 2020 agli Archiproducts Design Awards nella categoria Lighting.

Wireless atmospheric lighting with a touch dimmer, intended for indoor or outdoor use, for relaxing, reading or as a centrepiece. Use Ognidove to create custom compositions by combining the three finishes and adding flowers and/or dried branches. The lighting body and vase are fitted with magnets to enable you to position them on the base or on any ferrous surface. Ognidove won the international Winner2020 award at the Archiproducts Design Awards in the lighting category.

Stimmungslicht erzeugende kabellose Tischleuchte für drinnen und draußen, mit Berührungsdimmer. Zum Entspannen, zum Lesen und als Tischdekoration. Ognidove Tavolo ermöglicht zahlreiche Kompositionen durch die Kombination der drei Oberflächenarten mit Hinzufügung von Blumen und/oder trockenen Zweigen. Leuchtenkörper und Vase sind mit Magneten ausgestattet und lassen sich nach Belieben auf dem Standfuß oder auf eisenhaltigen Metallflächen aufstellen. Ognidove erhielt bei den Archiproducts Design Awards die internationale Auszeichnung „Winner 2020“ in der Kategorie Beleuchtung.

Lumière d'ambiance sans fil avec variateur tactile, pour intérieurs et extérieurs, pour la détente, la lecture et le centre de table. Ognidove tavolo permet de personnaliser les compositions en assortissant les trois finitions et en ajoutant des fleurs et/ou des branches sèches. Le corps de lampe et le vase, munis d'un aimant, peuvent être placés dans la position voulue, sur la base ou les surfaces en fer. Ognidove a reçu la reconnaissance internationale de Winner 2020 aux Archiproducts Design Awards dans la catégorie Lighting.

Luz ambiental inalámbrica con dimmer touch, para interiores y exteriores. Ideal para relajarse, leer y como centro de mesa. Ognidove tavolo permite crear diferentes composiciones combinando los tres acabados, con la adición de flores y/o ramas secas. El cuerpo de la lámpara y el florero, dotados de un imán, pueden colocarse como se desee en la base o en superficies de hierro. Ognidove ha recibido el reconocimiento internacional de Winner 2020 en los Archiproducts Design Awards en la categoría Lighting.









Design | Interni | Esterni

Ognidove tavolo

Luta Bettonica, Giancarlo Leone, 2020



Ognidove tavolo



Ø 2,8 cm
Ø 1 1/8"

Ognidove tavolo vaso

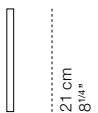

..
Ø 1,4 cm
Ø 1/2"

Ognidove tavolo base



Ø 14 cm
Ø 5 1/2"

 nero / black / schwarz / noir / negro

 oro / gold / Gold / or / oro

 argento / silver / Silber / argent / plata

light control available:

 integrated touch dimmer (max light on up to 7 hrs / min light on up to 70 hrs)

light emission available:

luce diffusa / diffused light / diffuses Licht / lumière diffuse / luz difusa

Led 2W / 2.700K / 260 lm / CRI90
(Li-Ion integrated rechargeable battery)

protection rating:
IP54

Design | Interni | Esterni

Ognidove terra

Luce d'atmosfera wireless con dimmer touch, per interni ed esterni, per il relax e la lettura. Ognidove terra permette la creazione di diverse composizioni abbinando le tre finiture, con l'aggiunta di fiori e/o rami secchi. Ognidove ha ricevuto il riconoscimento internazionale di Winner 2020 agli Archiproducts Design Awards nella categoria Lighting.

Wireless atmospheric lighting with a touch dimmer, intended for indoor or outdoor use, for relaxing and reading. Use Ognidove terra to create custom compositions by combining the three finishes and adding flowers and/or dried branches. Ognidove won the international Winner 2020 award at the Archiproducts Design Awards in the lighting category.

Stimmungslicht erzeugende kabellose Stehleuchte für drinnen und draußen, mit Berührungsdimmer. Zum Entspannen und zum Lesen. Ognidove Terra ermöglicht zahlreiche Kompositionen durch die Kombination der drei Oberflächenarten mit Hinzufügung von Blumen und/oder trockenen Zweigen. Ognidove erhielt bei den Archiproducts Design Awards die internationale Auszeichnung „Winner 2020“ in der Kategorie Beleuchtung

Lumière d'ambiance sans fil avec variateur tactile, pour intérieurs et extérieurs, pour la détente et la lecture. Ognidove terra permet de personnaliser les compositions en assortissant les trois finitions et en ajoutant des fleurs et/ou des branches sèches. Ognidove a reçu la reconnaissance internationale de Winner 2020 aux Archiproducts Design Awards dans la catégorie Lighting.

Luz ambiental inalámbrica con dimmer touch, para interiores y exteriores. Ideal para relajarse y leer. Ognidove terra permite crear diferentes composiciones combinando los tres acabados, con la adición de flores y/o ramas secas. Ognidove ha recibido el reconocimiento internacional de Winner 2020 en los Archiproducts Design Awards en la categoría Lighting.





Design | Interni | Esterni

Ognidove terra

Luta Bettonica, Giancarlo Leone, 2020



Ognidove terra

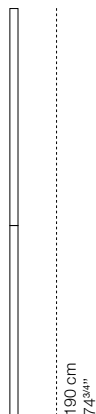

190 cm
74^{3/4}"

o

..
Ø 2,8 cm
Ø 1^{1/8}"

Ognidove terra vaso

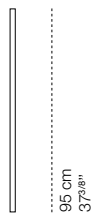

95 cm
37^{3/8}"

o

..
Ø 1,4 cm
Ø 1/2"

Ognidove terra base



.....
Ø 26 cm
Ø 10^{1/4}"

 nero / black / schwarz / noir / negro

 oro / gold / Gold / or / oro

 argento / silver / Silber / argent / plata

light control available:

 integrated touch dimmer (*max light on up to 7 hrs / min light on up to 70 hrs*)

light emission available:

luce diffusa / diffused light / diffuses Licht / lumière diffuse / luz difusa

Led 4W / 2.700K / 500 lm / CRI90
(*Li-Ion integrated rechargeable battery*)

protection rating:
IP54

Design | Interni

Roma

Luta Bettonica, 2020



Lampada da parete e da plafone dimmerabile per interni di grande potenza ed efficienza, a luce indiretta e diffusa, dal design essenziale e ultra-compatto. Una mattonella di metacrilato in forte spessore è sovrapposta ad una di pari dimensioni in acciaio laccato opaco, la prima contiene la luce, la seconda la diffonde.

A very powerful, efficient indoor wall and ceiling lamp with dimmer, for indirect and diffused light, with an utterly uncluttered, ultra-compact design. A brick made of thick methacrylate is set above another with the same dimensions, made of matt lacquered steel. The first contains the light, the second diffuses it.

Dimmbare Wand- und Deckenleuchte für den Innenbereich mit starker Lichtleistung und hoher Energieeffizienz. Mit Indirekt- und Streulicht. Von essenziellem und höchst kompaktem Design. Eine dicke Methacrylatfliese liegt hier auf einer gleich großen Fliese aus matt lackiertem Stahl: Die erste enthält das Licht, die zweite streut es.

Lampe de mur et plafond dimmable pour intérieurs, de forte puissance et performance, à lumière indirecte et diffuse, au design essentiel et ultra-compact. Un carreau en méthacrylate très épais est superposé à un autre de taille identique en acier laqué mat; le premier contient la lumière, le deuxième la diffuse.

Lámpara de pared y techo regulable en intensidad para interiores, de alta potencia y eficiencia, de luz indirecta y difusa, con un diseño esencial y ultracompacto. Una gruesa baldosa de metacrilato se superpone a una baldosa de acero lacado mate del mismo espesor; la primera contiene la luz y la segunda la difunde.



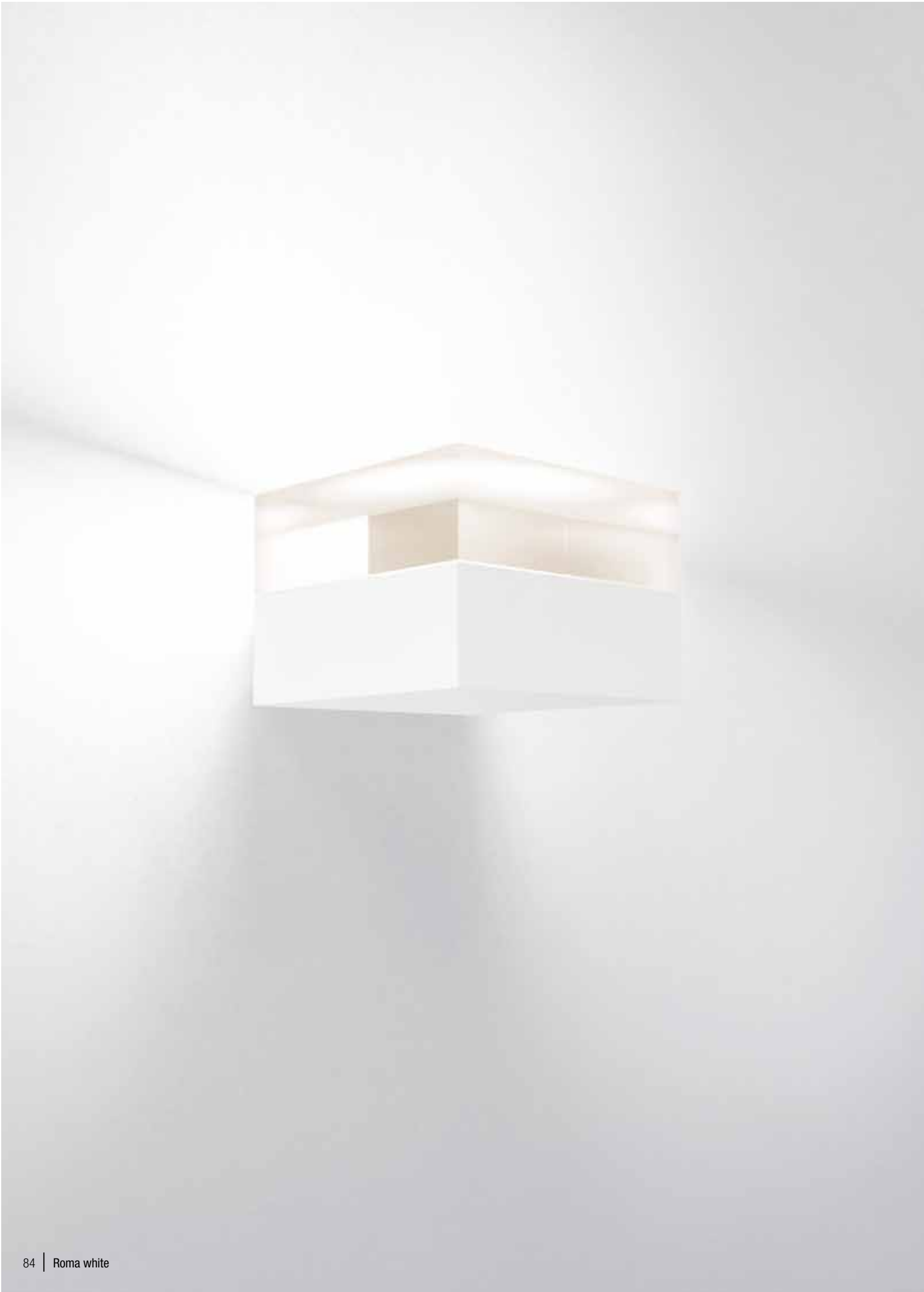

Roma

Luta Bettonica, 2020



Roma

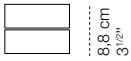

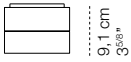

12x12 cm
4^{3/4}x4^{3/4}"

Roma plafone



12x12 cm
4^{3/4}x4^{3/4}"

 bianco / white / weiß / blanc / blanco

 tortora chiaro / light dove grey / graubraun hell / taupe clair / gris pardo claro

 tortora scuro / dark dove grey / graubraun dunkel / taupe foncé / gris pardo oscuro

 nero / black / schwarz / noir / negro

light control available:

 phase cut dimmable

 push dimmable

 dali

 casambi integrated

light emission available:

luce indiretta e diffusa / indirect and diffused light / indirektes und diffuses Licht / lumière indirecte et diffuse / luz indirecta y difusa

ROMA
led 20W / 2.400 lm / 2.700K / CRI90

ROMA PLAFONE
led 13W / 2.000 lm / 2.700K / CRI90



Roma



Roma plafone

Design | Interni

Sferico

Lata Bettonica, 2018



Sferico sospeso

Lampada a sospensione per interni a doppia emissione per luce diretta e indiretta. Dimmerabile da comandi tradizionali e Casambi. Disponibile in versione bianco, argento e oro opaco, è corredata da calotte in metacrilato trasparente con lenti concentranti per luce puntuale oppure opalescenti per luce diffusa. L'elevato Indice di Resa Cromatica (CRI) garantisce il rispetto della percezione dei colori e la corretta illuminazione dell'ambiente. E' disponibile un accessorio per il rosone che permette di collegare più lampade in serie.

A twin-emission indoor suspension luminaire for direct and indirect light. Can be dimmed using traditional controls and Casambi. Available in white, matt gold and silver versions, it comes with transparent methacrylate domes with focusing lenses for accent lighting or opalescent lenses for soft diffused lighting. The luminaire's high colour rendering index (CRI) guarantees respect for colour perception and correct ambient light. A ceiling rose accessory is available that enables several luminaires to be connected in series.

Hängeleuchte für den Innenbereich mit zweifacher Lichtausgabe für Direkt- und Indirektlicht. Dimmbar über herkömmliche Regler und mittels CASAMBI-Lichtsteuerung. Erhältlich in den Ausführungen Weiß, Silber und Mattgold. Ausgestattet mit Halbkugeln aus transparentem Methacrylat mit konzentrierenden Linsen für Punktlicht oder opaleszierend für Streulicht. Der hohe CRI-Farbwiedergabeindex gewährleistet eine natürliche Farbwahrnehmung und eine korrekte Raumbelichtung. Für die Rosette ist ein Zubehörteil erhältlich, das die Installation mehrerer Leuchten in Reihe erlaubt.

Lampe d'intérieur à suspension pour un éclairage à double émission de lumière, directe et indirecte. Réglable à l'aide d'appareils de commande traditionnels et par Casambi. Disponible en version blanc, argent et or mat, elle est équipée de calottes en méthacrylate transparent avec des lentilles concentrées pour une lumière ponctuelle, ou opalescente pour une lumière diffuse. L'élevé Indice de Rendu des Couleurs (CRI) garantit le respect de la perception des couleurs et l'éclairage correct de l'espace. Un accessoire pour la rosette est disponible pour relier plusieurs lampes en série.

Lámpara de suspensión para interiores de doble emisión para luz directa e indirecta. La intensidad se puede regular con controles tradicionales y también con Casambi. Disponible en versión con acabado blanco, plateado y dorado mate, tiene casquetes de metacrilato transparente con lentes que concentran los rayos de luz para una luz puntual, o bien casquetes opalescentes para una luz difusa. El elevado índice de rendimiento cromático (CRI) asegura el respeto de la percepción de los colores y la correcta iluminación del ambiente. Está disponible un accesorio para el florón que permite conectar varias lámparas en serie.







Sferico sospeso

Luta Bettonica, 2018



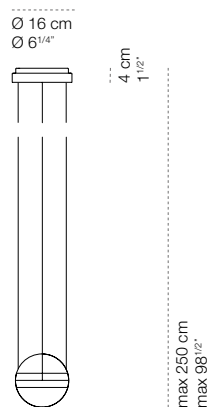

Sferico sospeso



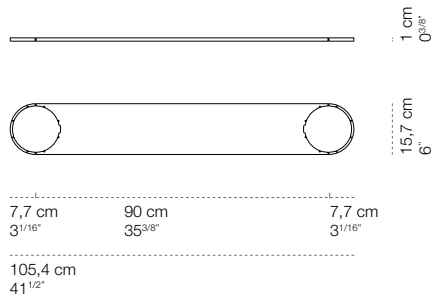

Ø 14 cm
Ø 5 1/2"

Sferico sospeso rosone 90



 bianco / white / weiß / blanc / blanco

 oro opaco / matt gold / Gold matt / or mat / oro mate

 argento opaco / matt silver / Silber matt / argent mat / plata mate

caps available:

 trasparente / transparent / transparent / transparent / transparente

 opalescente / opalescent / opaleszierend / opalescente / opalescente

light control available:

 phase cut dimmable

 casambi integrated

light emission available:

luce diretta e indiretta / direct and indirect light / direktes und indirektes Licht / lumière directe et indirecte / luz directa y indirecta

led 2x9W / 2x1.100 lm / 2.700K / CRI92



Sferico sospeso



Sferico sospeso (x2) + Sferico sospeso rosone 90

Design | Interni

Fludd

Alessandro Scandurra, 2018



Sospensione e plafoniera per interni a luce diffusa, dimmerabile da comandi di tipo tradizionale e Casambi. Un disco trasparente con mini-prismature antiabbaglianti, rifrange la luce emessa dall'elemento diffondente superiore e la concentra verso il basso dando forma ad una lampada dal particolare effetto ottico. La luce diffusa e schermata di Fludd rende la versione sospesa adatta per installazioni a qualsiasi altezza mentre la versione a plafone illumina anche il soffitto. L'alto Indice di Resa Cromatica (CRI) garantisce il rispetto della percezione dei colori e la corretta illuminazione dell'ambiente.

An indoor suspension and ceiling lamp for diffused light that can be dimmed using traditional controls and Casambi. A transparent disc with anti-glare mini-prisms breaks down the light emitted by the upper emission element and concentrates it downwards, giving shape to a luminaire with an unusual optical effect. The Fludd's diffused, shaded light makes the suspended version suitable for installation at any height, while the ceiling version also illuminates the ceiling. The luminaire's high colour rendering index (CRI) guarantees respect for colour perception and correct ambient light.

Hänge- und Deckenleuchte für den Innenbereich mit Streulicht, dimmbar über herkömmliche Regler und CASAMBI-Lichtsteuerung. Eine transparente Scheibe mit feinsten Blendschutzprismen bricht das vom oberen Element ausgegebene Licht und konzentriert es nach unten, wodurch eine besondere optische Wirkung erzeugt wird. Auf Grund des gestreuten und abgeschirmten Lichts von Fludd eignet sich die Hängeleuchtenausführung für Installationen in jeder beliebigen Höhe, während die Deckenleuchtenversion auch zur Decke hin Licht abgibt. Der hohe CRI-Farbwiedergabeindex gewährleistet eine natürliche Farbwahrnehmung und eine korrekte Raumbeleuchtung.

Lampe d'intérieur à suspension et plafonnière à lumière diffuse, réglable à l'aide d'appareils de commande traditionnels et par Casambi. Un disque transparent avec mini-prismatures antireflet réfracte la lumière émise par l'élément de diffusion supérieur et la concentre vers le bas en donnant forme à une lampe d'un effet optique spécial. La lumière diffuse et protégée de Fludd rend la version suspendue adaptée aux installations à n'importe quelle hauteur, tandis que la version au plafond éclaire également le plafond. L'élevé Indice de Rendu des Couleurs (CRI) garantit le respect de la perception des couleurs et l'éclairage correct de l'espace.

Lámpara de suspensión y de techo para interiores de luz difusa, con regulador de intensidad con control tradicional y Casambi. Un disco transparente con mini-prismas antideslumbrantes, refracta la luz emitida por un elemento propagador superior y la concentra hacia abajo, dando forma a una lámpara con un particular efecto óptico. La luz difusa y escudada de Fludd hace que el modelo de suspensión sea ideal para instalaciones a cualquier altura, mientras que el modelo de techo ilumina también el cielorraso. El elevado índice de rendimiento cromático (CRI) asegura el respeto de la percepción de los colores y la correcta iluminación del ambiente.





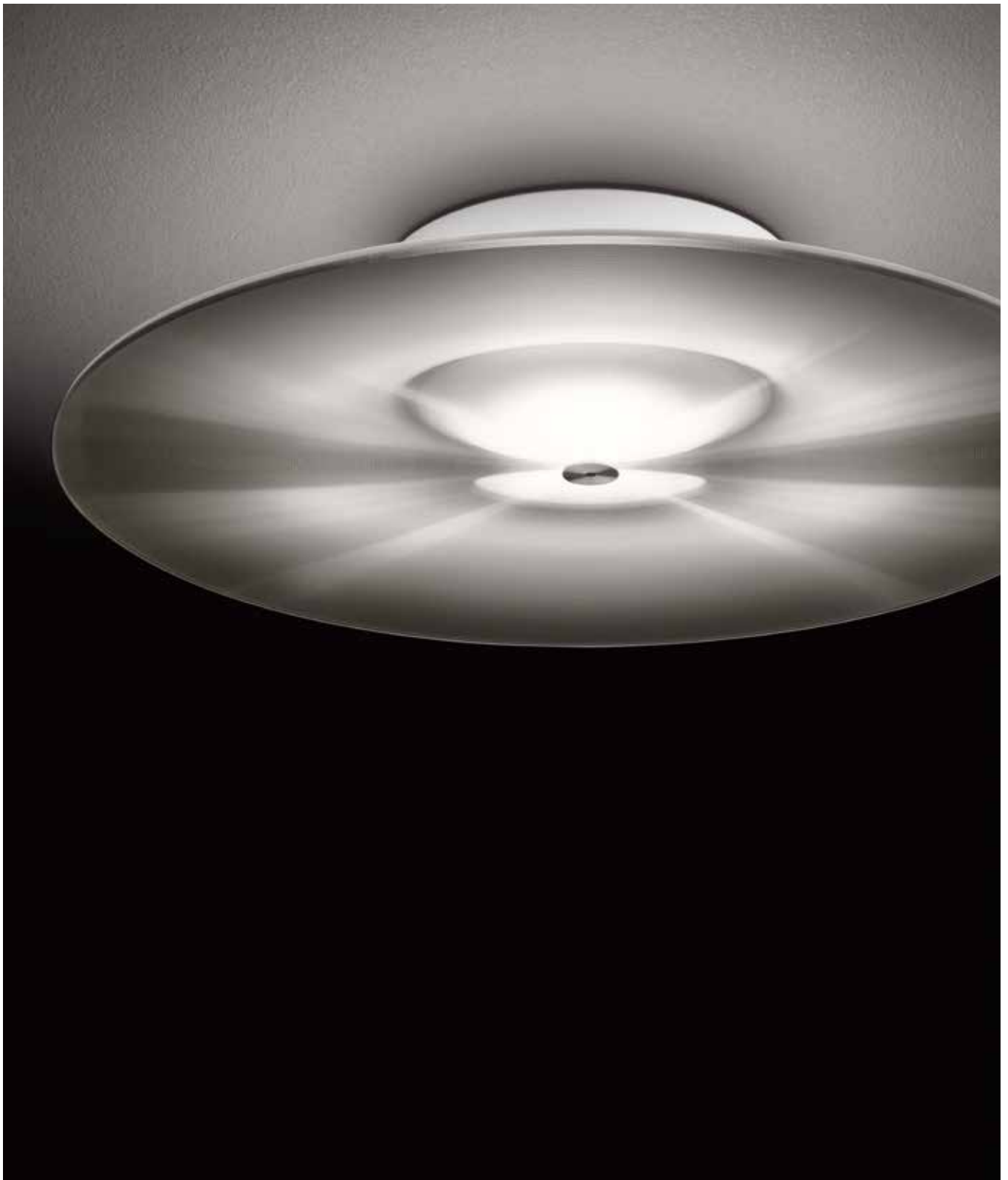



Fludd sospesa e plafone

Alessandro Scandurra, 2018



Fludd plafone

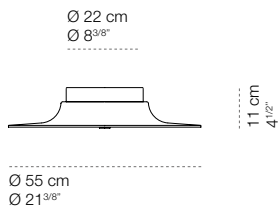

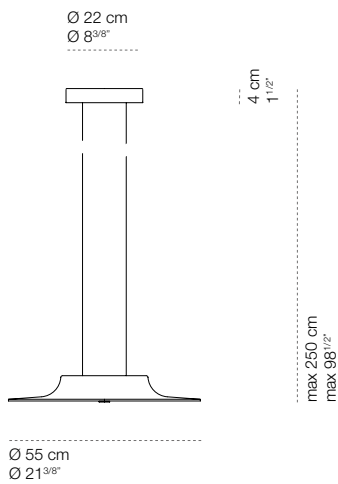

Fludd sospesa



 opalescente-trasparente / opalescent-transparent / opaleszierend-transparent / opalescente-transparent / opalescente-transparente

light control available:

 phase cut dimmable

 push dimmable

 dali

 casambi integrated

light emission available:

luce diffusa / diffused lighting / diffuses Licht / lumière diffuse / luz difusa

led 30W / 3.800 lm / 2.700K / CRI92

protection rating:

IP40 (only Fludd plafone)



Fludd sospesa



Fludd plafone

Design | Interni

Stilo

Lata Bettonica, 2016



Stilo sospeso

Lampada a sospensione per interni a luce diffusa, bi-emissione e dimmerabile da comandi di tipo tradizionale e Casambi. Disponibile in versione bianco e nero opaco. Il rosone può essere posizionato a piacere in prossimità della lampada, i regolatori permettono l'installazione orizzontale o inclinata. La versione con alimentatore remoto è priva di rosone e permette l'installazione in serie. L'alto Indice di Resa Cromatica (CRI) garantisce il rispetto della percezione dei colori e la rende adatta a qualsiasi tipo di ambiente.

An indoor suspension lamp with diffused, twin-emission lighting that can be dimmed using traditional controls and Casambi. Available in matt black and white versions. The ceiling rose can be installed anywhere near the luminaire, while adjustments enable it to be installed horizontally or on a slope. The version with a remote power supply needs no ceiling rose and allows for installation in series. The luminaire's high colour rendering index (CRI) guarantees respect for colour perception and makes it suitable for any kind of location.

Hängeleuchte für den Innenbereich mit Streulicht und zweifacher Lichtausgabe, dimmbar über herkömmliche Regler und CASAMBI-Lichtsteuerung. Erhältlich in den Ausführungen Weiß und Mattschwarz. Die Rosette kann an einer beliebigen Stelle in der Nähe der Leuchte angebracht werden. Die Verstellelemente erlauben sowohl eine waagerechte als auch eine geneigte Installation. Die Ausführung mit fern montierter Speiseeinheit benötigt keine Rosette und ermöglicht die Installation in Reihe. Der hohe CRI-Farbwiedergabeindex gewährleistet eine natürliche Farbwahrnehmung und macht die Leuchte für jede Art von Raum geeignet.

Lampe d'intérieur à suspension à lumière diffuse, à double émission et réglable à l'aide d'appareils de commande traditionnels et de Casambi. Disponible en version blanc et noir mat. La rosette peut être positionnée comme désiré près de la lampe, les régulateurs permettent l'installation horizontale ou inclinée. La version avec alimentation à distance est sans rosette et permet l'installation en série. L'élevé Indice de Rendu des Couleurs (CRI) garantit le respect de la perception des couleurs et l'éclairage correct de l'espace.

Lámpara de suspensión para interiores de luz difusa, de doble emisión y con regulador de intensidad con control tradicional y Casambi. Disponible en versión con acabado blanco y negro mate. El florón se puede colocar cerca de la lámpara en la posición que se desee, los reguladores permiten la instalación horizontal o inclinada. La versión con fuente de alimentación remota no tiene florón y permite la instalación en serie. El alto índice de rendimiento cromático (CRI) asegura el respeto de la percepción de los colores y hace que sea ideal para cualquier tipo de ambiente.







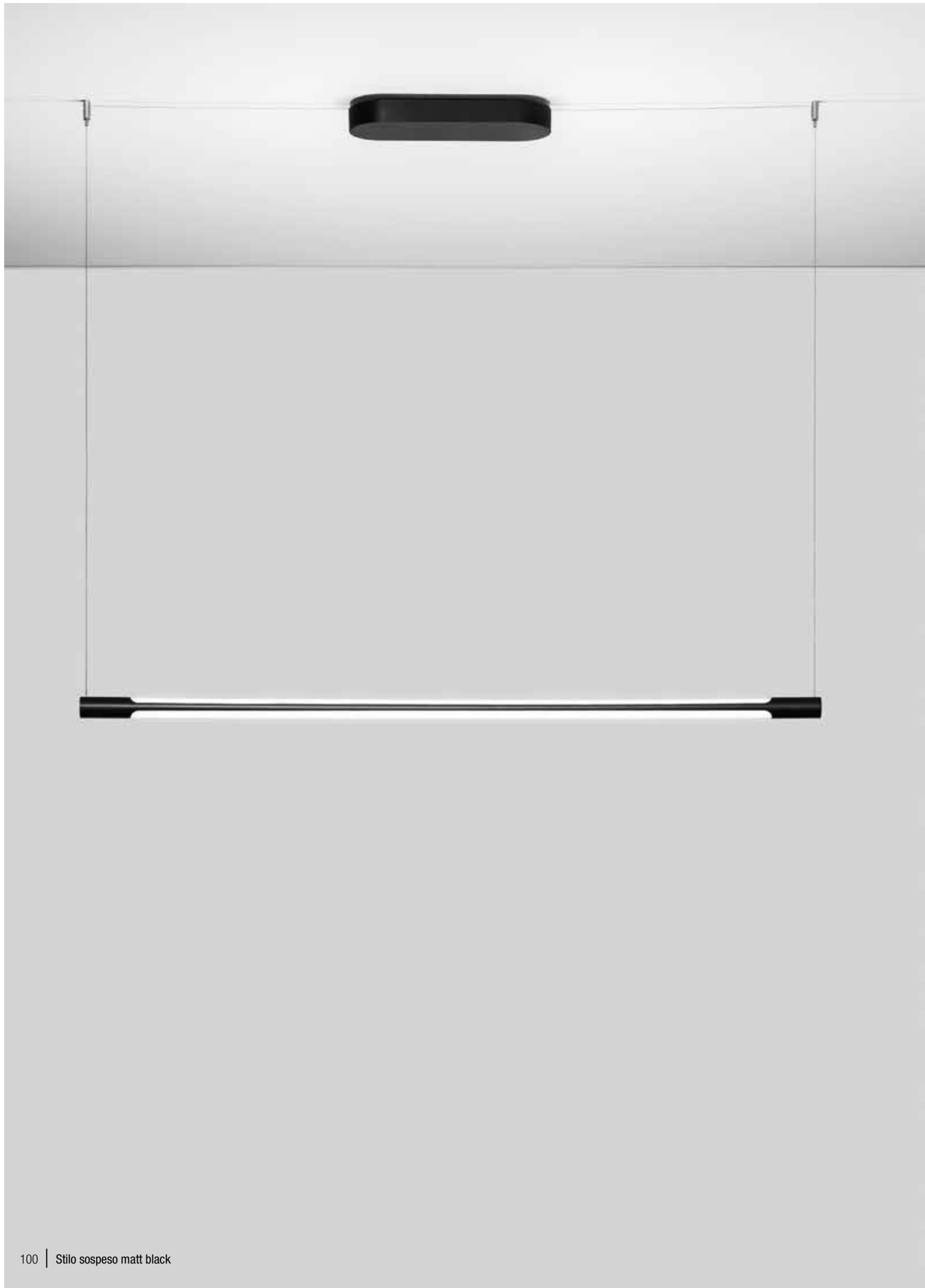

Stilo sospeso

Luta Bettonica, 2016-2018



Stilo sospeso

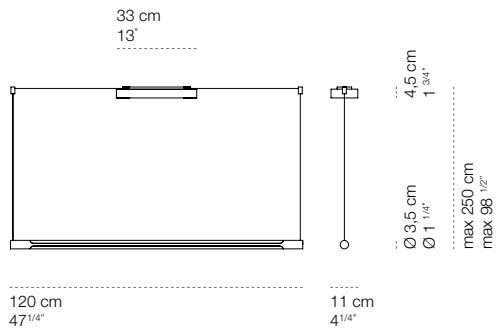

Stilo sospeso driver remoto

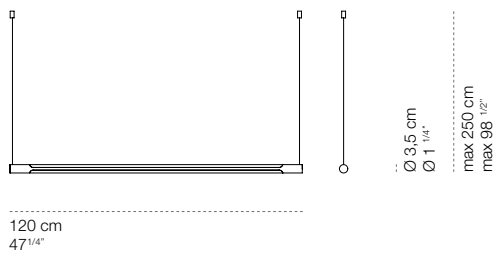

○ bianco opaco / matt white / Deckweiß / blanc mat / blanco mate

● nero opaco / matt black / Deckschwarz / noir mat / negro mate

light control available:

◐ phase cut dimmable

◑ push dimmable

 dali

 casambi integrated

light emission available:

luce diretta e indiretta / direct and indirect light / direktes und indirektes Licht /
lumière directe et indirecte / luz directa y indirecta

led 2x24W / 2x2.400 lm / 2.700K / CRI90



Stilo sospeso



Stilo sospeso



Stilo sospeso driver remoto

Design | Interni

Acqua

Lata Bettonica, 2014



Lampada dimmerabile componibile in alluminio pressofuso, per luce riflessa diretta e/o indiretta. I moduli, disponibili in 3 finiture, grazie all'innesto rapido si agganciano tra loro e ai diversi accessori per essere installati a sospensione o a terra, creando infinite configurazioni. Acqua ha ricevuto tre riconoscimenti internazionali: il Miaw ai Muuuz International Awards 2015 nella categoria Lighting, la Menzione Speciale al Premio Codega 2016, il Best of Category Lighting agli Archiproducts Design Awards 2016.

A modular luminaire made of die-cast aluminium with dimming, for direct and/or indirect reflected light. A rapid connector enables the modules, available in three finishes, to be connected to each other and to a variety of accessories for installation as a suspension or floor lamp, creating an infinite choice of configurations. Acqua has won three international awards: the MIAW in the Lighting category of the 2015 Muuuz International Awards 2015, a Special Mention in the 2016 Codega Award and the Best of Category for Lighting in the 2016 Archiproducts Design Awards.

Modulare dimmbare Leuchte aus Druckgussaluminium-Elementen mit direktem und/oder indirektem reflektierten Licht. Die in drei verschiedenen Ausführungen erhältlichen Module lassen sich durch eine Schnellsteckverbindung miteinander kombinieren und erlauben dank weiterer Zubehörteile Häng- oder Stehinstallationen mit unendlich vielen Konfigurationsmöglichkeiten. Acqua wurde mit drei internationalen Design-Preisen ausgezeichnet: dem MIAW-Preis der MUUUZ International Awards 2015 in der Kategorie Lighting, der Besonderen Erwähnung beim CODEGA-Preis 2016 sowie dem Preis Best of Category Lighting bei den Archiproducts Design Awards 2016.

Lampe modulaire dimmable, en aluminium moulé sous pression, pour une lumière réfléchiée directe et/ou indirecte. Les modules, disponibles en 3 finitions, grâce à une jonction rapide peuvent être fixés l'un à l'autre et aux différents accessoires et placés à suspension ou à terre, en créant une grande variété d'installations. Acqua a reçu trois prix internationaux: le MIAW aux Muuuz International Awards 2015 dans la catégorie Lighting, la Mention Spéciale du prix Codega 2016, le Best of Category Lighting aux Archiproducts Design Awards.

Lámpara con regulador de intensidad, componible, de aluminio vaciado a presión, para luz refleja directa y/o indirecta. Los módulos, disponibles en 3 acabados, gracias al acoplado rápido, se enganchan entre ellos y a los varios accesorios formando lámparas de suspensión o de pie, creando configuraciones infinitas. Acqua ha recibido tres reconocimientos internacionales: el Miaw en los Muuuz International Awards 2015 en la categoría Lighting, la Mención especial en el Premio Codega 2016 y el Best of Category Lighting en los Archiproducts Design Awards 2016.















Acqua filo + Acqua corpo illuminante uplight matt gold (x3), uplight white (x1), downlight matt silver (x2) | 109

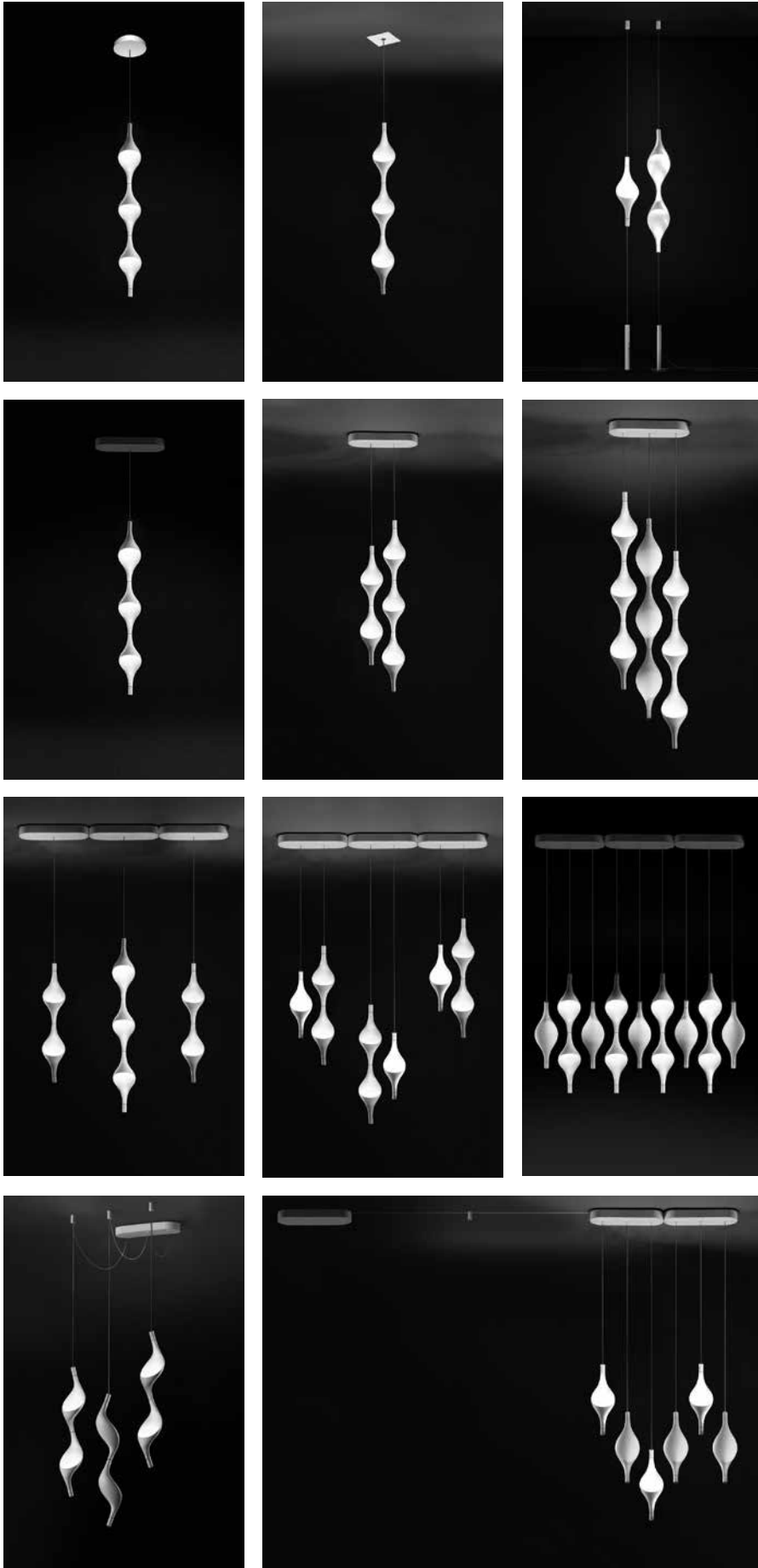

Acqua

Luta Bettonica, 2014



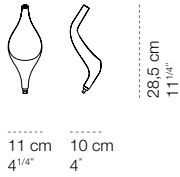

Acqua uplight



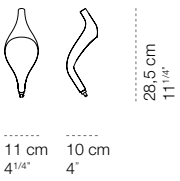



Acqua downlight



-  bianco / white / weiß / blanc / blanco
-  oro opaco / matt gold / Gold matt / or mat / oro mate
-  argento opaco / matt silver / Silber matt / argent mat / plata mate

light control available:

-  on-off (only Acqua filo)
-  push dimmable (no Acqua filo)
-  switch dimmable (no Acqua filo)
-  dali (only Acqua rosone incasso)

light emission available:

downlight > luce diretta e riflessa / direct and reflected light / direktes und reflektiertes Licht / lumière directe et réfléchie / luz directa y refleja

uplight > luce indiretta e riflessa / indirect and reflected light / indirektes und reflektiertes Licht / lumière indirecte et réfléchie / luz indirecta y refleja

led 5,6W / 650 lm / 2.700K / CRI95

Design | Interni

Passepartout

Luta Bettonica, 2016



Passepartout parete

Lampada da parete per interni dimmerabile a luce indiretta. Passepartout parete, sottile ed elegante è disponibile nella finitura oro lucido con struttura in colore opaco e nelle finiture cromo lucido, nero e bianco opaco con struttura in alluminio diamantato. L'elevato Indice di Resa Cromatica (CRI) rispetta la naturale percezione dei colori.

An indoor wall lamp for indirect light with dimming. Slim and elegant, the Passepartout parete is available in a polished gold finish with a structure in a matt colour and in polished chrome, matt white and black finishes with a structure in diamond-finished aluminium. The luminaire's high colour rendering index (CRI) guarantees respect for colour perception.

Dimmbare Wandleuchte für den Innenbereich mit indirekter Lichtausgabe. Die schlank und elegant geformte Passepartout parete ist in der Ausführung Gold glanzpoliert mit mattfarbigem Tragelement sowie in den Ausführungen Glanzchrom, Schwarz und Mattweiß mit Tragelement aus diamantgeschliffenem Aluminium erhältlich. Der hohe CRI-Farbwiedergabeindex gewährleistet eine natürliche Farbwahrnehmung.

Lampe d'intérieur de mur dimmable à lumière indirecte. Passepartout parete, mince et élégante, est disponible dans la finition or poli avec une structure en couleur mate et dans les finitions chrome poli, noir et blanc mat avec une structure en aluminium finition diamant. L'élevé Indice de Rendu des Couleurs (CRI) respecte la naturelle perception des couleurs.

Lámpara de pared para interiores, de luz indirecta, con posibilidad de regular la intensidad. Passepartout parete, fina y elegante, está disponible con acabado dorado brillante con estructura de color mate y con acabados cromo brillante, negro y blanco mate con estructura en aluminio adiamantado. El elevado índice de rendimiento cromático (CRI) respeta la natural percepción de los colores.



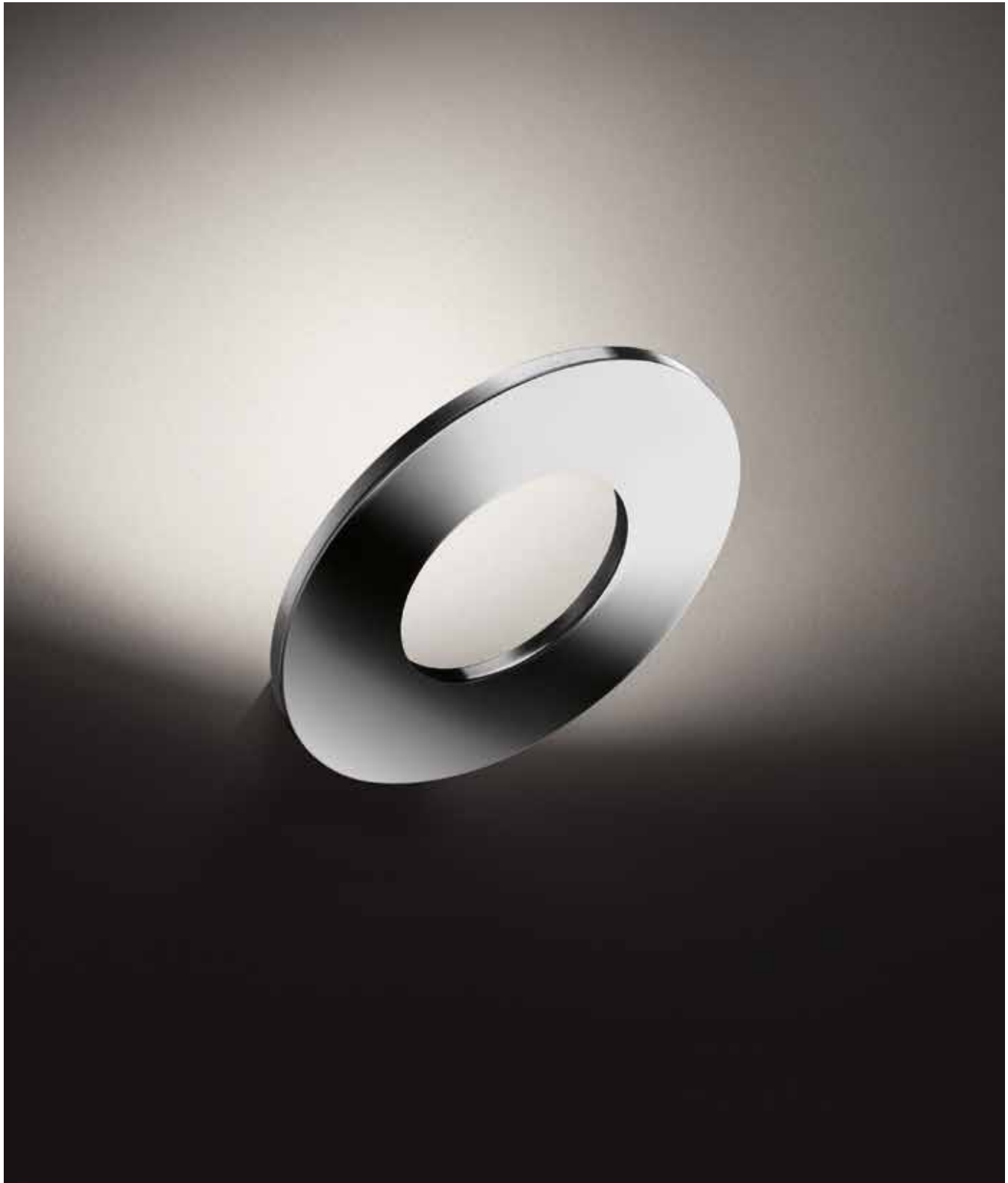





Passepartout parete

Luta Bettonica, 2016

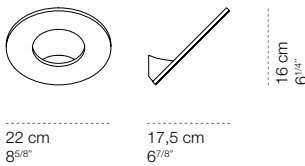

22 cm
8^{5/8}"

17,5 cm
6^{7/8}"

16 cm
6^{1/4}"



bianco opaco, struttura alluminio diamantato / matt white, diamond-finished aluminium structure / Deckweiß-Emaillackierung, Tragelement aus diamantgeschliffenem Aluminium / blanc mat, structure en aluminium diamanté / blanco mate, estructura en aluminio adiamantado.



nero opaco, struttura alluminio diamantato / matt black, diamond-finished aluminium structure / Deckschwarz-Emaillackierung, Tragelement aus diamantgeschliffenem Aluminium / noir mat, structure en aluminium diamanté / negro mate, estructura en aluminio adiamantado.



cromo lucido, struttura alluminio diamantato / polished chrome, diamond-finished aluminium structure / glanzverchromt, Tragelement aus diamantgeschliffenem Aluminium / chrome brillant, structure en aluminium diamanté / cromo brillante, estructura en aluminio adiamantado



oro lucido, struttura oro opaco / polished gold, structure in matt gold / glanzpoliertes Gold, Tragelement mit matter Gold-Emaillackierung / or brillant, structure en or mat / oro brillante, estructura oro mate

light control available:

 phase cut dimmable

light emission available:

luce indiretta / indirect light / indirektes Licht / lumière indirecte / luz indirecta

led 18W / 2.200 lm / 2.700K / CRI95

Passepartout25 sopratavolo

Sospensione sopratavolo per interni a doppia emissione luminosa dimmerabile. Disponibile anche con dimmer sensoriale touchless o Casambi integrato, nelle finiture oro con struttura opaca, cromo lucido, nero e bianco opaco con struttura in alluminio diamantato. Ideale per installazioni singole e multiple su piani, tavoli o banconi a sviluppo longitudinale. L'elevato Indice di Resa Cromatica (CRI) rispetta la naturale percezione dei colori e la combinazione delle due sorgenti rende la luce equilibrata. E' disponibile un accessorio per il rosone che permette di collegare più lampade in serie.

Sospensione sopratavolo is a twin light emission luminaire for interiors with dimming. Also available with touchless sensory or built-in Casambi dimming, the finishes are gold with a matt-coloured structure, or polished chrome, matt white or black with a structure in diamond-finished aluminium. Ideal for single or multiple installations on surfaces or over tables or long counters. The luminaire's high colour rendering index (CRI) guarantees respect for colour perception and the combination of the two sources makes the light balanced. A ceiling rose accessory is available that enables several luminaires to be connected in series.

Tisch-Hängeleuchte für den Innenbereich mit zweifacher dimmbarer Lichtausgabe. Erhältlich auch mit berührungslosem Dimmersensor oder eingebauter CASAMBI-Lichtsteuerung sowie in den Ausführungen Gold mit mattem Tragelement, Glanzchrom, Schwarz und Mattweiß mit Tragelement aus diamantgeschliffenem Aluminium. Ideal für Einzel- oder Reiheninstallationen zur Beleuchtung von Flächen, Tischen, Tresen oder Theken in Längsrichtung. Der hohe CRI-Farbwiedergabeindex gewährleistet eine natürliche Farbwahrnehmung, während die Kombination der beiden Lichtquellen für ausgewogenen Belechtungskomfort sorgt. Für die Rosette ist ein Zubehörteil erhältlich, das die Installation mehrerer Leuchten in Reihe ermöglicht.

Lampe d'intérieur à suspension sur table, réglable à double émission de lumière. Disponible également avec variateur sensoriel touchless ou Casambi intégré, dans les finitions or avec une structure mate, chrome poli, noir et blanc mat avec une structure en aluminium finition diamant. Idéale pour des installations simples et multiples sur des plans, des tables ou des comptoirs avec un développement longitudinal. L'élevé Indice de Rendu des Couleurs (CRI) respecte la naturelle perception des couleurs et la combinaison des deux sources rend la lumière équilibrée. Un accessoire pour la rosette est disponible, ce qui permet de relier plusieurs lampes en série.

Suspensión para interiores, ideal para iluminar la mesa, con doble emisión luminosa regulable en intensidad. Disponible también con regulador sensorial sin contacto (dimmer touchless) o Casambi integrado, con acabados dorado con estructura opaca, cromo brillante, negro y blanco mate con estructura en aluminio adiamantado. Ideal para instalaciones únicas o múltiples sobre mostradores, barras, mesas o superficies que se extienden en sentido longitudinal. El elevado índice de rendimiento cromático (CRI) respeta la natural percepción de los colores y la combinación de las dos fuentes luminosas hace que la luz sea equilibrada. Está disponible un accesorio para el florón que permite conectar varias lámparas en serie.







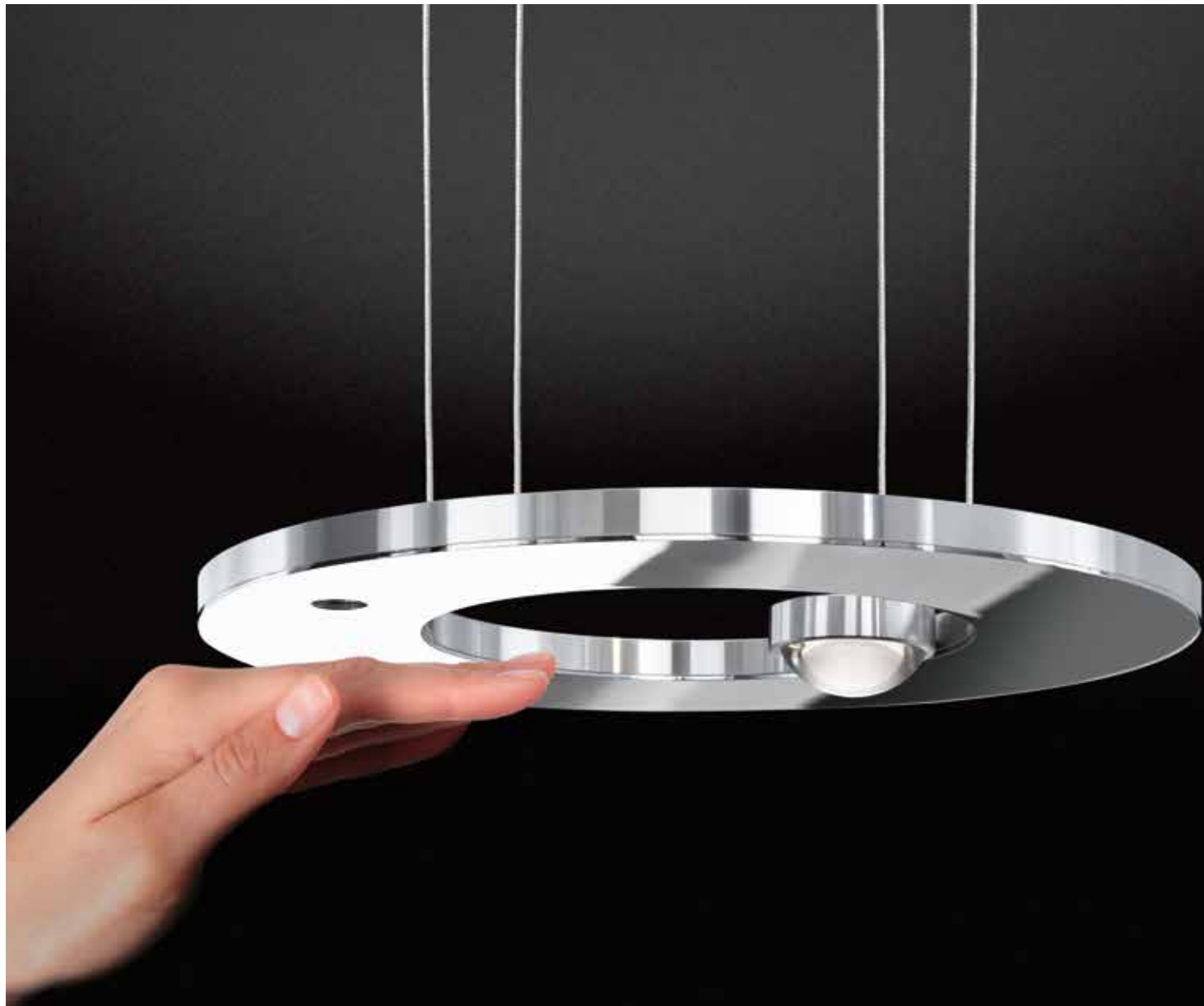

Passepartout25 sopratavolo

Luta Bettonica, 2017



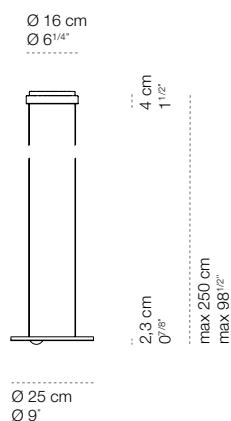

Passepartout25 sopratavolo



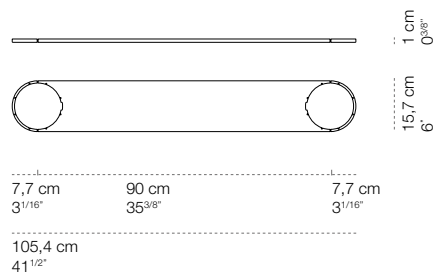

Passepartout25 rosone 90





 bianco opaco, struttura alluminio diamantato / matt white, diamond-finished aluminium structure / Deckweiß-Emaillackierung, Tragelement aus diamantgeschliffenem Aluminium / blanc mat, structure en aluminium diamanté / blanco mate, estructura en aluminio adiamantado.

 nero opaco, struttura alluminio diamantato / matt black, diamond-finished aluminium structure / Deckschwarz-Emaillackierung, Tragelement aus diamantgeschliffenem Aluminium / noir mat, structure en aluminium diamanté / negro mate, estructura en aluminio adiamantado.

 cromo lucido, struttura alluminio diamantato / polished chrome, diamond-finished aluminium structure / glanzverchromt, Tragelement aus diamantgeschliffenem Aluminium / chrome brillant, structure en aluminium diamanté / cromo brillante, estructura en aluminio adiamantado

 oro lucido, struttura ottone opaco / polished gold, structure in matt brass / glanzpoliertes Gold, Tragelement mit matter Messing-Emaillackierung / or brillant, structure en laiton mat / oro brillante, estructura en latón mate

light control available:

-  phase cut dimmable (no Passepartout25 sensor)
-  casambi integrated (no Passepartout25 sensor)
-  integrated touchless dimmer (only Passepartout25 sensor)

light emission available:

luce diretta e indiretta / direct and indirect light / direktes und indirektes Licht / lumière directe et indirecte / luz directa y indirecta

lower emission: led 9W / 1.000 lm / 2.700K / CRI92
 upper emission: led 2x5W / 2x600 lm / 2.700K / CRI92



Passepartout25
sopratavolo



Passepartout25
sopratavolo sensor



Passepartout25 sopratavolo (x2) +
Passepartout25 rosone 90

Passepartout55 sopratavolo

Sospensione sopratavolo per interni a doppia emissione luminosa con doppia accensione e dimmerabilità. Disponibile anche in versione Casambi integrato per la gestione della luce da dispositivi mobili. Il disco centrale in acciaio lucidato a specchio è accostato a un ampio anello disponibile in sei finiture: oro lucido, cromo lucido, oro opaco, argento opaco, nero opaco e bianco opaco. L'elevato Indice di Resa Cromatica (CRI) rispetta la naturale percezione dei colori e la combinazione delle due sorgenti rende la luce equilibrata.

Sospensione sopratavolo is a twin light emission luminaire for interiors with twin switching and dimming. Also available with built-in Casambi dimming for managing light from mobile devices. The central disc made of steel polished to a mirror finish combines with a large ring available with six finishes: polished gold, polished chrome, matt gold, matt silver, matt black and matt white. The luminaire's high colour rendering index (CRI) guarantees respect for colour perception and the combination of the two sources makes the light balanced.

Tisch-Hängeleuchte für den Innenbereich mit zweifacher Lichtausgabe und zweifacher Schalt- und Dimmbarkeit. Erhältlich auch als Ausführung mit eingebauter CASAMBI-Steuerung zur Lichtregelung mittels mobiler Geräte. Die mittlere Scheibe aus hochglanzpoliertem Stahl ist mit einem weiten Ring versehen, der in sechs Ausführungen erhältlich ist: Gold glanzpoliert, Glanzchrom, Mattgold, Mattsilber, Mattschwarz und Mattweiß. Der hohe CRI-Farbwiedergabeindex gewährleistet eine natürliche Farbwahrnehmung, während die Kombination der beiden Lichtquellen für eine ausgewogene Beleuchtung sorgt.

Lampe d'intérieur à suspension sur table, à double émission de lumière, avec double allumage et gradation. Également disponible en version Casambi, intégré pour la gestion de la lumière par des dispositifs mobiles. Le disque central en acier poli-miroir est disposé à côté d'un grand anneau disponible en six finitions: or poli, chrome poli, or mat, argent mat, noir mat et blanc mat. L'élevé Indice de Rendu des Couleurs (CRI) garantit la naturelle perception des couleurs et la combinaison des deux sources rend la lumière équilibrée.

Suspensión para interiores, ideal para iluminar la mesa, con doble emisión luminosa, doble encendido y posibilidad de regulación de intensidad. Disponible también en la versión Casambi integrado para la gestión de la luz desde dispositivos móviles. El disco central de acero pulido a espejo se combina con un anillo ancho disponible en seis acabados: dorado brillante, cromo brillante, dorado mate, plateado mate, negro mate y blanco mate. El elevado índice de rendimiento cromático (CRI) respeta la natural percepción de los colores y la combinación de las dos fuentes luminosas hace que la luz sea equilibrada.













Passepartout55 sopratavolo

Luta Bettonica, 2017

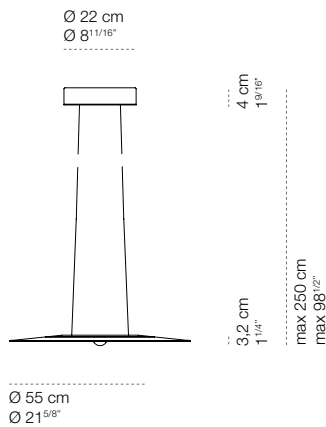

bianco opaco e inox specchio / matt white and mirror-finish stainless steel / Deckweiß-Emaillelackierung und Edelstahl spiegelpoliert / blanc mat et acier inoxydable miroir / blanco mate y acero inoxidable pulido a espejo



nero opaco e inox specchio / matt black and mirror-finish stainless steel / Deckschwarz-Emaillelackierung und Edelstahl spiegelpoliert / noir mat et acier inoxydable miroir / negro mate y acero inoxidable pulido a espejo



cromo lucido e inox specchio / polished chrome and mirror-finish stainless steel / glanzverchromt und Edelstahl spiegelpoliert / chrome brillant et acier inoxydable miroir / cromo brillante y acero inoxidable pulido a espejo



oro lucido e inox specchio / polished gold and mirror-finish stainless steel / glanzpoliertes Gold und Edelstahl spiegelpoliert / or brillant et acier inoxydable miroir / oro brillante y acero inoxidable pulido a espejo



argento opaco e inox specchio / matt silver and mirror-finish stainless steel / matte Silber-Emaillelackierung und Edelstahl spiegelpoliert / argent mat et acier inoxydable miroir / plateado mate y acero inoxidable pulido a espejo



oro opaco e inox specchio / matt gold and mirror-finish stainless steel / matte Gold-Emaillelackierung und Edelstahl spiegelpoliert / or mat et acier inoxydable miroir / oro mate y acero inoxidable pulido a espejo

light control available:



phase cut dimmable, double switch



casambi integrated, double switch

light emission available:

luce diretta e indiretta / direct and indirect light / direktes und indirektes Licht / lumière directe et indirecte / luz directa y indirecta

lower emission: led 13W / 1.300 lm / 2.700K / CRI92

upper emission: led 16W / 1.500 lm / 2.700K / CRI92

Passepartout terra

Lampada da terra per interni a luce indiretta, con dimmer sensoriale per gestire accensione, spegnimento e dimmerazione con il solo passaggio e soffermarsi della mano. Passepartout terra è disponibile nelle finiture oro lucido con struttura opaca; cromo lucido con struttura in alluminio diamantato; nero e bianco opaco con struttura in alluminio diamantato e stelo in colore abbinato. L'elevato Indice di Resa Cromatica (CRI) rispetta la naturale percezione dei colori.

A floor lamp with indirect light for interiors, with a sensory dimmer for managing switching on and off and controlling light intensity by simply moving a hand or holding it still in the vicinity. Passepartout terra is available with a matt gold finish and a matt-coloured structure, a polished chrome finish with a diamond-finished structure, or a matt black or white finish with a diamond-finished structure and an upright in a matching colour. The luminaire's high colour rendering index (CRI) guarantees respect for colour perception.

Stehleuchte für den Innenbereich mit Indirektlicht, mit Berührungsdimmer zum Ein- und Ausschalten sowie zum Dimmen durch längere Berührung mit der Hand. Passepartout terra ist in den Ausführungen Gold glanzpoliert mit mattem Tragelement, Glanzchrom mit Tragelement aus diamantgeschliffenem Aluminium sowie Schwarz und Mattweiß mit Tragelement aus diamantgeschliffenem Aluminium und Schaft in passender Farbe erhältlich. Der hohe CRI-Farbwiedergabeindex gewährleistet eine natürliche Farbwahrnehmung.

Lampe de terre d'intérieur à lumière indirecte, avec gradateur sensoriel pour allumer et éteindre et variateur d'intensité, activé par le seul passage de la main. Passepartout terra est disponible dans les finitions or poli avec une structure mate; chrome poli avec une structure en aluminium finition diamant; noir et blanc mat avec une structure en aluminium diamanté et la tige en couleur assortie. L'élevé Indice de Rendu des Couleurs (CRI) garantit le respect de la perception naturelle des couleurs.

Lámpara de pie para interiores, de luz indirecta con dimmer sensorial que permite encender, apagar y regular la intensidad de la luz simplemente pasando o deteniendo la mano cerca del regulador. Passepartout terra está disponible en acabados dorado brillante con estructura opaca; cromo brillante con estructura en aluminio adiamantado; negro y blanco mate con estructura en aluminio adiamantado y pie en un color combinado. El elevado índice de rendimiento cromático (CRI) respeta la natural percepción de los colores.









Passepartout terra

Luta Bettonica, 2016

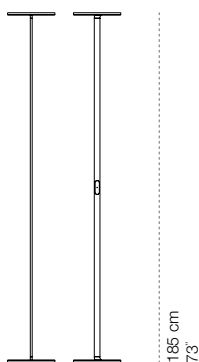

Ø 25 cm
Ø 97/8"



anelli e stelo bianco opaco, struttura alluminio diamantato e satinato / rings and stem in matt white, structure in satin and diamond-finished aluminium / Ringe und Schaft mit Deckweiß-Emaillackierung, Tragelement aus Aluminium, diamantgeschliffen und satiniert / anneaux et tige en blanc mat, structure en aluminium diamanté et satiné / anillos y pie en blanco mate, estructura de aluminio adiamantado y satinado



anelli e stelo nero opaco, struttura alluminio diamantato e satinato / rings and stem in matt black, structure in satin and diamond-finished aluminium / Ringe und Schaft mit Deckschwarz- Emaillackierung, Tragelement aus Aluminium, diamantgeschliffen und satiniert / anneaux et tige en noir mat, structure en aluminium diamanté et satiné / anillos y pie en negro mate, estructura de aluminio adiamantado y satinado



anelli cromo lucido, stelo e struttura acciaio satinato e alluminio diamantato / rings in polished chrome, stem and structure in satin-finish steel and diamond-finished aluminium / Ringe glanzverchromt, Schaft und Tragelement aus satiniertem Stahl und diamantgeschliffenem Aluminium / anneaux en chrome brillant, tige et structure en acier satiné et aluminium diamanté / anillos de cromo brillante, pie y estructura de acero satinado y aluminio adiamantado



anelli oro lucido, stelo e struttura oro opaco / rings in polished gold, stem and structure in matt gold / Ringe aus glanzpoliertem Gold, Schaft und Tragelement mit matter Gold-Emaillackierung / anneaux en or brillant, tige et structure en or mat / anillos de oro brillante, pie y estructura en oro mate

light control available:



integrated touchless dimmer

light emission available:

luce indiretta / indirect light / indirektes Licht / lumière indirecte / luz indirecta

led 35W / 4.000 lm / 2.700K / CRI92

Design | Interni

Bouquet

Franco e Luta Bettonica, 1965/2006



Bouquet abbinata classicità, eleganza e originalità a utilizzi poliedrici. Protagonista sul tavolino da notte o nell'angolo di uno spazio giorno, Bouquet dona una luce soffusa adatta alla lettura ed al relax. Una scultura luminosa che una volta accesa mette in risalto i delicati giochi di chiaroscuro creati dalla "pieghe" del diffusore. Il design dell'abatjourina (2006) è firmato da Luta Bettonica e Mario Melocchi, un omaggio al progetto originario di Franco Bettonica che nel 1965 si ispirò ad un origami per dar vita a un vaso in ceramica dalla forma eccentrica.

Bouquet combines classicism, elegance and originality with multifaceted uses. Protagonist on the night table or in the corner of a living space, Bouquet gives a soft light suitable for reading and relaxing. A luminous sculpture that once switched on highlights the delicate play of chiaroscuro created by the 'folds' of the diffuser. The design of the abatjourine (2006) is by Luta Bettonica and Mario Melocchi, a tribute to the original design by Franco Bettonica who was inspired by origami in 1965 to create an eccentrically shaped ceramic vase.

Bouquet verbindet Klassizismus, Eleganz und Originalität mit vielseitigen Einsatzmöglichkeiten. Als Protagonist auf dem Nachttisch oder in der Ecke eines Wohnraums spendet Bouquet ein sanftes Licht, das zum Lesen und Entspannen einlädt. Eine leuchtende Skulptur, die, sobald sie eingeschaltet ist, das zarte Hell-Dunkel-Spiel der "Falten" des Schirms hervorhebt. Das Design der Abatjourine (2006) stammt von Luta Bettonica und Mario Melocchi und ist eine Hommage an den ursprünglichen Entwurf von Franco Bettonica, der sich 1965 von Origami zu einer exzentrisch geformten Keramikvase inspirieren ließ.

Bouquet allie classicisme, élégance et originalité à des usages multiples. Protagoniste sur la table de nuit ou dans un coin de l'espace de vie, Bouquet diffuse une lumière douce propice à la lecture et à la détente. Une sculpture lumineuse qui, une fois allumée, met en valeur le délicat jeu de clair-obscur créé par les "plis" du diffuseur. Le design de l'abatjourine (2006) est signé Luta Bettonica et Mario Melocchi, en hommage au design original de Franco Bettonica qui s'est inspiré de l'origami en 1965 pour créer un vase en céramique aux formes excentriques.

Bouquet combina clasicismo, elegancia y originalidad con usos polifacéticos. Protagonista en la mesilla de noche o en el rincón de una sala de estar, Bouquet proporciona una luz suave adecuada para leer y relajarse. Una escultura luminosa que, una vez encendida, resalta el delicado juego de claroscuros creado por los "pliegues" del difusor. El diseño de la abatjourine (2006) es obra de Luta Bettonica y Mario Melocchi, un homenaje al diseño original de Franco Bettonica, que en 1965 se inspiró en la papiroflexia para crear un jarrón de cerámica de formas excéntricas.



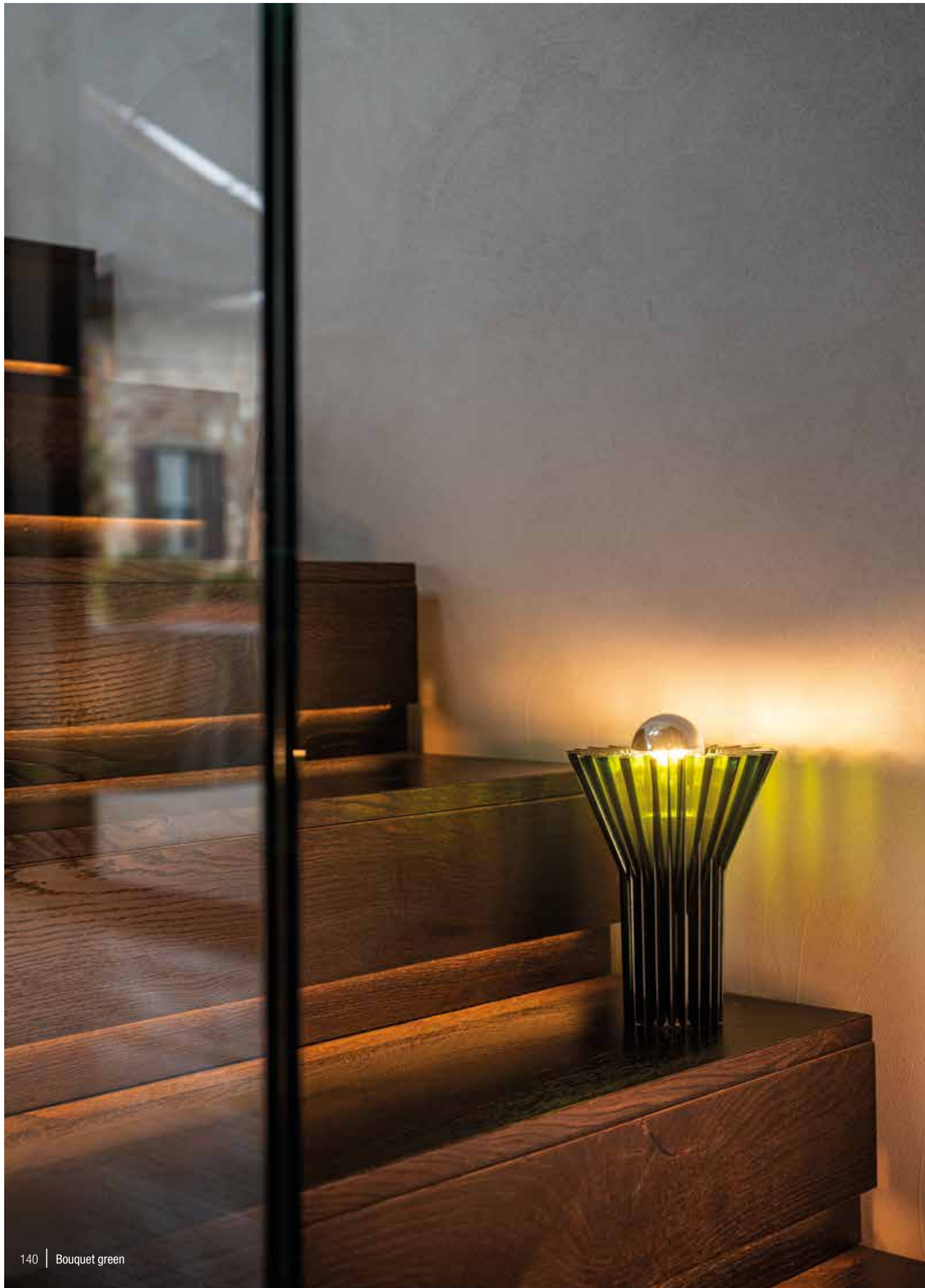







sul tavolino da notte o
nell'angolo di uno spazio giorno



Design | Interni

Bouquet

Franco e Luta Bettonica, 1965/2006

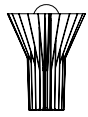

25 cm
9 7/8"



18 cm
7 1/8"

 opale / opal / opal / opale / opal

 trasparente / transparent / transparent / transparent / transparente

 rosso / red / rot / rouge / rojo

 verde / green / grün / vert / verde

light control available:

 dimmable

light emission available:

luce diffusa / diffused light / diffuses Licht / lumière diffuse / luz difusa

led E27 / 60W / 230V (bulb included)

Design | Interni

Cuboluce

Franco Bettonica, Mario Melocchi 1972-2013-2018



Cuboluce classic / Cuboluce led / Cuboluce wireless

Cuboluce, lo apri si accende, lo chiudi si spegne. La storica lampada disegnata nel 1972 è oggi disponibile in tre versioni e nove finiture. Cuboluce classic, con lampadina attacco E14. Cuboluce led, con led integrato. Cuboluce wireless, con led integrato e batteria ricaricabile agli ioni di litio ad elevata autonomia di utilizzo.

Cuboluce: open it and up and the light comes on; close it and the light goes off. The timeless lamp designed in 1972 is now available in three versions and nine finishes: Cuboluce classic, with an E14 bulb attachment, Cuboluce led, with a built-in led, and Cuboluce wireless, with a built-in led and rechargeable lithium ion battery with extensive autonomy.

Cuboluce: Deckel auf, Licht an – Deckel zu, Licht aus. Diese historische Cini&Nils Leuchte von 1972 ist heute in drei Versionen und neun Ausführungen erhältlich: Cuboluce classic mit Glühlampenfassung E14, Cuboluce led mit integriertem led-Leuchtmittel und Cuboluce wireless mit integriertem led-Leuchtmittel und wiederaufladbarem Lithiumionen-Akku mit langer Betriebsautonomie.

Cuboluce s'allume quand on ouvre son couvercle et s'éteint lorsqu'on le ferme. La lampe historique conçue en 1972 est actuellement disponible en trois versions et neuf finitions. Cuboluce Classic, avec ampoule à douille E14. Cuboluce led, avec led intégrée. Cuboluce wireless, avec led intégrée et batterie lithium-ion rechargeable avec une autonomie de fonctionnement élevée.

Cuboluce: abriéndolo se enciende, cerrándolo se apaga. La histórica lámpara diseñada en 1972 hoy está disponible en tres versiones y nueve acabados. Cuboluce classic, con bombilla de casquillo E14. Cuboluce led, con led integrado. Cuboluce wireless, con led integrado y batería recargable de iones de litio de elevada autonomía de uso.





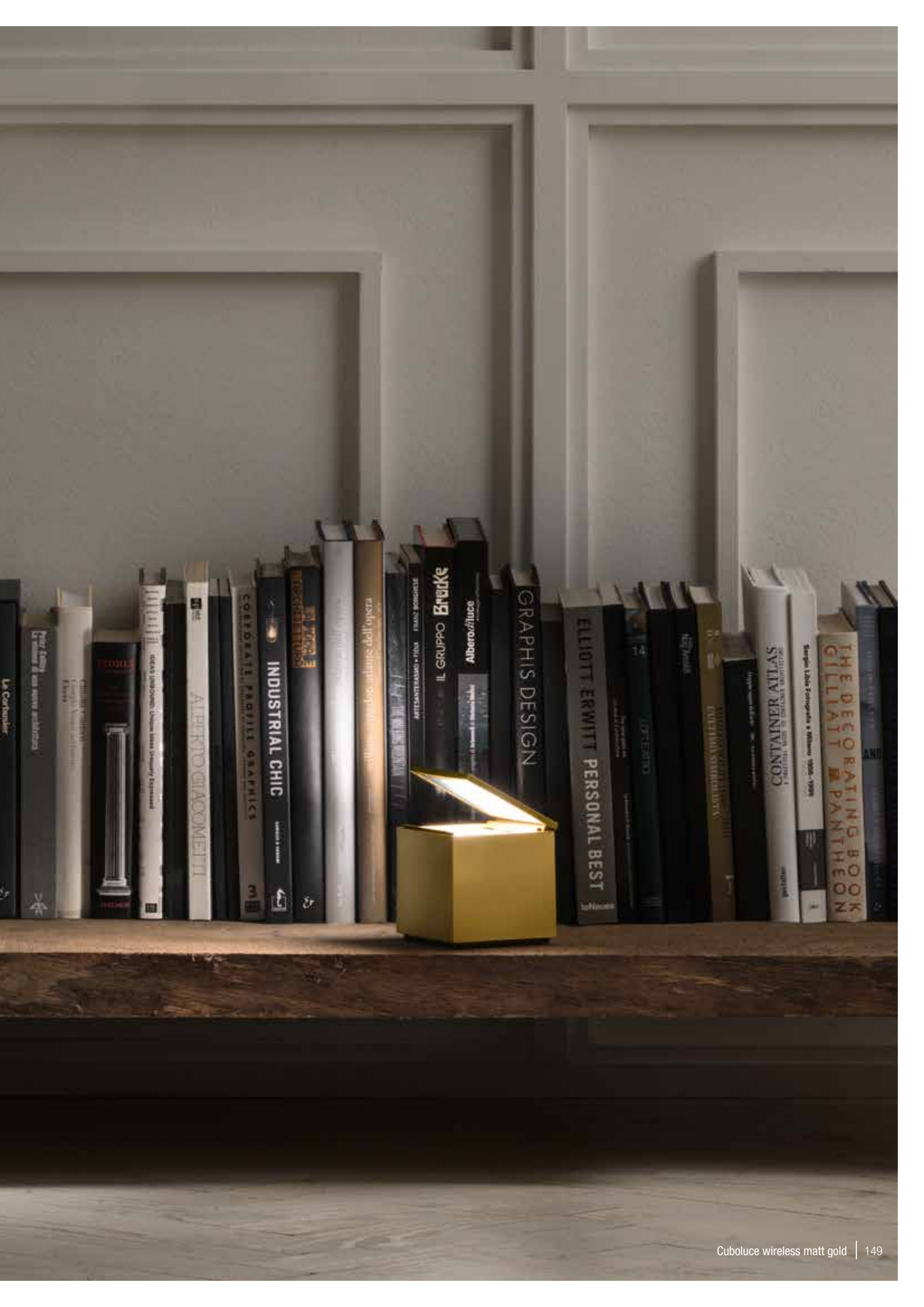

Le Corbusier
Le Corbusier e la nuova architettura
Gianluigi Neri
Idee di un'architettura
Alessandro Mendini
CORPORATE PROFILE GRAPHICS
INDUSTRIAL CHIC
ELIOTT ERWITT
ALBERO DI LUCE
IL GRUPPO Brücke
GRAPHIS DESIGN
ELLIOTT ERWITT PERSONAL BEST
CONTAINER AULAS
THE DECORATING BOOK
GILLIAT PANTHEON





Cuboluce classic / Cuboluce led / Cuboluce wireless

Franco Bettonica, Mario Melocchi 1972-2013-2018

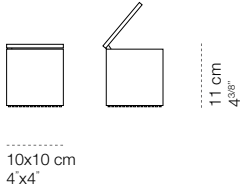

Cuboluce classic
led bulb



Cuboluce led
integrated led



Cuboluce wireless
rechargeable



Cuboluce classic / Cuboluce led / Cuboluce wireless

-  bianco / white / weiß / blanc / blanco
-  rosso / red / rot / rouge / rojo
-  nero / black / schwarz / noir / negro
-  laccaseta denim / silk lacquer denim / Denim seidenmatt / laque soie denim / laca mate denim
-  laccaseta verde / silk lacquer green / Grün seidenmatt / laque soie vert / laca mate verde
-  laccaseta antracite / silk lacquer anthracite / Anthrazit seidenmatt / laque soie anthracite / laca mate antracita
-  argento / silver / Silber / argent / plateado
-  oro opaco / matt gold / Gold matt / or mat / oro mate
-  giallo-verde-blu-arancione-rosso / yellow-green-blue-orange-red / gelb-grün-blau-orange-rot / jaune-vert-bleu-orange-rouge / amarillo-verde-azul-naranja-rojo

light emission available:

luce indiretta / indirect light / indirektes Licht / lumière indirecte / luz indirecta

CUBOLUCE CLASSIC

led E14 3W / 2.700K / CRI80 / 230V (bulb included)

CUBOLUCE LED

led 2W / 2.700K / CRI90

CUBOLUCE WIRELESS

led 2W / 2.700K / CRI90 (Li-Ion integrated rechargeable battery - Autonomy 8hrs)

Design | Interni

Incontro

Lata Bettonica, 2015



Lampada da parete e da plafone per interni a luce riflessa e indiretta. Incontro, caratterizzata da due lingue estroflesse in metallo laccato che si incontrano sottili alle loro estremità, è disponibile nelle finiture oro, argento e bianco opaco. La sorgente, mai visibile, permette l'installazione a tutte le altezze e l'orientamento in qualsiasi direzione. Disponibile in versione dimmerabile con Indice di Resa Cromatica (CRI) ad alta fedeltà di percezione dei colori naturali, oppure in versione on/off con Indice di Resa Cromatica ad alta efficienza luminosa.

An indoor wall and ceiling lamp emitting reflected and indirect light. Featuring a combination of two slim lacquered metal tabs that splay outwards in parallel and come to meet at their extremities, Incontro is available in matt white, gold and silver finishes. The light source is never visible and enables the lamp to be installed at any height on the wall or ceiling and pointing in any direction. Available in a dimming version with a high-performance natural colour perception colour rendering index (CRI), or in an on/off version with a high lighting efficiency colour rendering index.

Wand- und Deckenleuchte für den Innenbereich mit reflektiertem und indirektem Licht. Die Besonderheit von Incontro sind ihre zwei nach außen gebogenen dünnen Bänder aus lackiertem Metall, die sich an ihren Enden vereinen. Erhältlich in den Ausführungen Gold, Silber und Mattweiß. Da die Lichtquelle von keinem Blickwinkel aus einsehbar ist, lässt sich die Leuchte in jeder beliebigen Höhe und Ausrichtung installieren. Erhältlich als dimmbare Ausführung mit besonders natürlicher Farbwahrnehmung durch einen hohen CRI-Farbwiedergabeindex oder als Ein/Aus-Version mit CRI-Farbwiedergabeindex von hohem Beleuchtungswirkungsgrad.

Lampe d'intérieur de mur et de plafond à lumière réfléchie et indirecte. Incontro, caractérisée par une paire de languettes en métal laqué repliées vers l'extérieur qui se soudent fines et parallèles à leurs extrémités, est disponible dans les finitions en or, argent et blanc mat. La source jamais visible, permet l'installation à n'importe quelle hauteur et l'orientation dans n'importe quelle direction. Disponible en version réglable avec Indice de Rendu des Couleurs (CRI) à haute-fidélité de perception des couleurs naturelles, ou en version on/off avec Indice de Rendu des Couleurs à haute efficacité lumineuse.

Lámpara de pared o de techo para interiores, de luz refleja e indirecta. Incontro, caracterizada por dos lenguas extravertidas de metal lacado que convergen, finas, en sus extremos, está disponible en los acabados dorado, plateado y blanco mate. La fuente luminosa, nunca a la vista, permite que se instale a cualquier altura y que se pueda orientar en cualquier dirección. Disponible en versión regulable en intensidad con índice de rendimiento cromático (CRI) de alta fidelidad de percepción de los colores naturales, o bien en versión on/off con índice de rendimiento cromático de alta eficiencia luminosa.

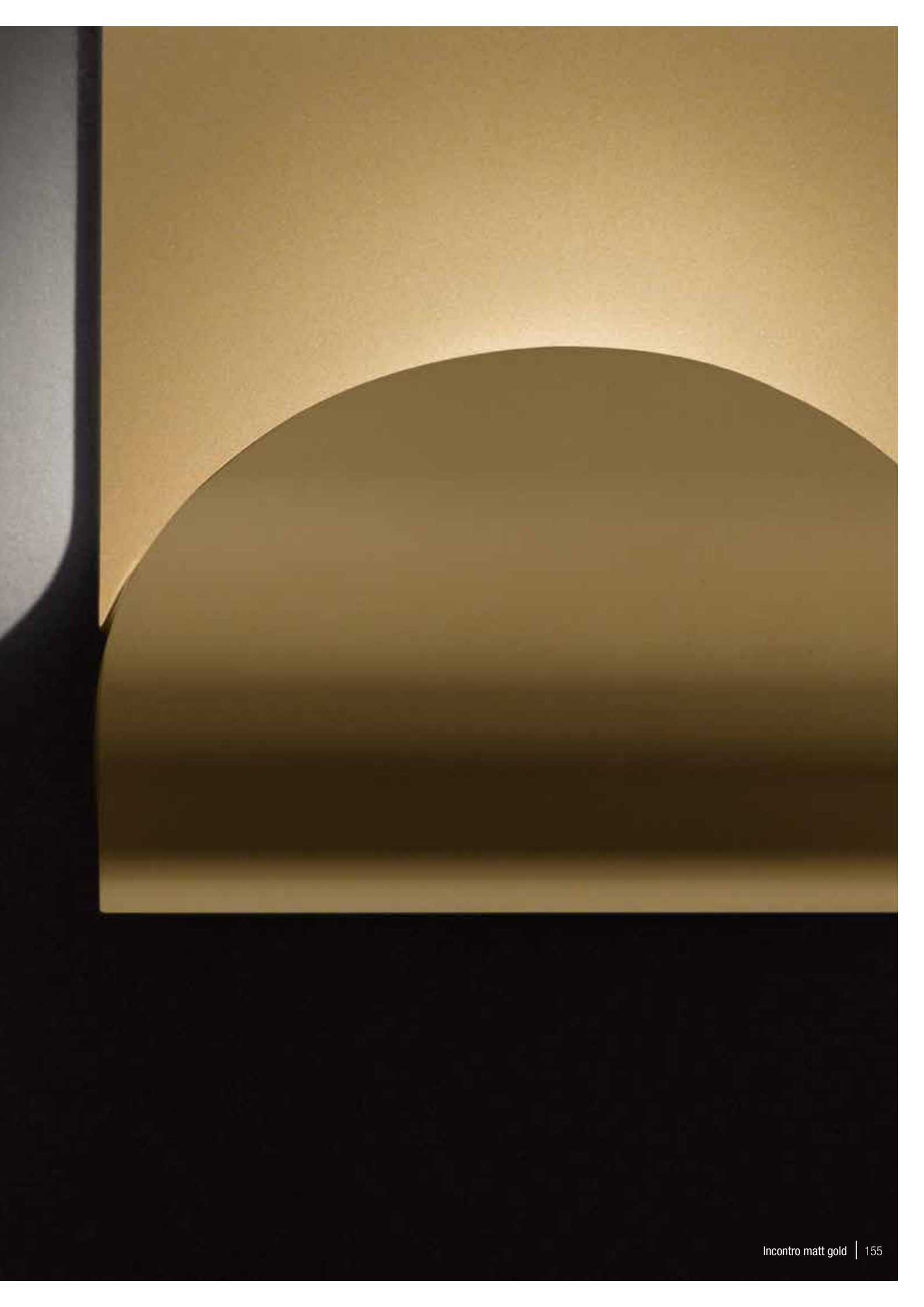







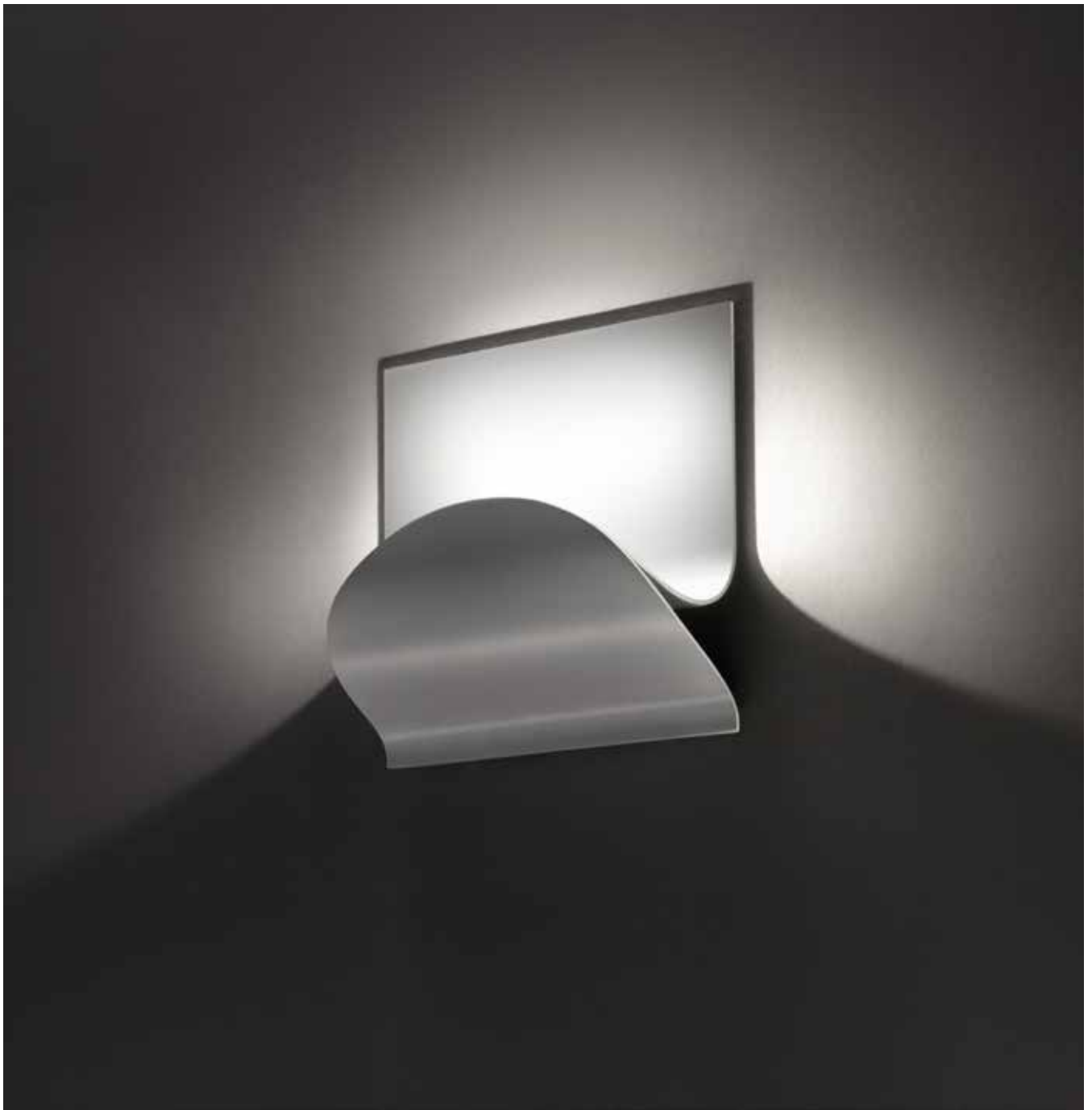



Design | Interni

Incontro

Luta Bettonica, 2015



21,5 cm
8¹/₂"



7,5 cm
3"

21,5 cm
8¹/₂"



bianco / white / weiß / blanc / blanco



oro opaco / matt gold / Gold matt / or mat / oro mate



argento opaco / matt silver / Silber matt / argent mat / plata mate

light control available:



on-off



phase cut dimmable

light emission available:

luce indiretta / indirect light / indirektes Licht / lumière indirecte / luz indirecta

on-off: led 13W / 1.800 lm / 2.700K / CRI80

phase cut dimmable: led 15W / 1.700 lm / 2.700K / CRI90

Design | Interni

Assolo

Lata Bettonica, 2015



Assolo43 / Assolo70

Lampade per interni dimmerabili a luce indiretta della famiglia Assolo, diametro 43 o 70 cm, caratterizzate dalle suggestive sottolineature di luce e dal design compatto e lineare, disponibili in versione sospesa, plafone, appoggio e terra. Le finiture bianco e nero opaco valorizzano l'essenzialità del cerchio perfetto con un segno netto e definito, mentre la finitura oro opaco accentua la classicità della forma e valorizza l'ambiente con raffinatezza. L'elevato Indice di Resa Cromatica (CRI) rispetta la naturale percezione dei colori.

An indoor luminaire with dimmer for indirect light from the Assolo family, featuring the evocative stress of light and a compact linear design, available in suspended, ceiling lamp, tabletop and floor lamp versions and with a 43 or 70 cm diameter. The matt black and white finishes enhance the essential simplicity of the perfect circle with a clearly-defined sign, while the matt gold finish underscores the classical timelessness of the form and adds a touch of refinement to every interior. The luminaire's high colour rendering index (CRI) guarantees respect for colour perception.

Dimmbare Leuchten der Familie Assolo für den Innenbereich mit indirekter Lichtausgabe, Durchmesser 43 oder 70 cm, die sich durch suggestive Lichtakzente und ein kompaktes, lineares Design auszeichnen. Erhältlich als Hänge-, Decken-, Tisch- oder Stehleuchtenversion. Die Ausführungen Weiß und Mattschwarz unterstreichen die Essenz der perfekten Kreisform mit einem klar abgesetzten Zeichen, während die Ausführung Mattgold markant die Klassik der Form betont und ihre Umgebung mit Raffinesse bereichert. Der hohe CRI-Farbwiedergabeindex gewährleistet eine natürliche Farbwahrnehmung.

Lampes d'intérieur réglables à lumière indirecte de la famille Assolo, de 43 ou 70 cm de diamètre, caractérisées par des reflets saisissants et par un design linéaire et compact, disponibles en versions suspension, plafond, appui et sol. Les finitions blanc et noir mat renforcent le caractère essentiel de la circonférence parfaite avec un signe clair et précis, tandis que la finition or mat accentue le classicisme de la forme et valorise l'espace avec son charme. L'élevé Indice de Rendu des Couleurs (CRI) garantit le respect de la perception de la couleur et l'éclairage correct de l'environnement.

Pertenecientes a la familia Assolo, son lámparas para interiores regulables en intensidad, de luz indirecta, de 43 o 70 cm de diámetro, caracterizadas por sus sugestivos realces de luz y por su diseño compacto y lineal. Están disponibles en modelos de suspensión, de techo, de apoyo y de pie. Los acabados blanco y negro mate valorizan la esencialidad del círculo perfecto con una línea neta y definida, mientras que el acabado dorado mate acentúa lo clásico de la forma y valoriza el ambiente con elegancia. El elevado índice de rendimiento cromático (CRI) respeta la natural percepción de los colores.







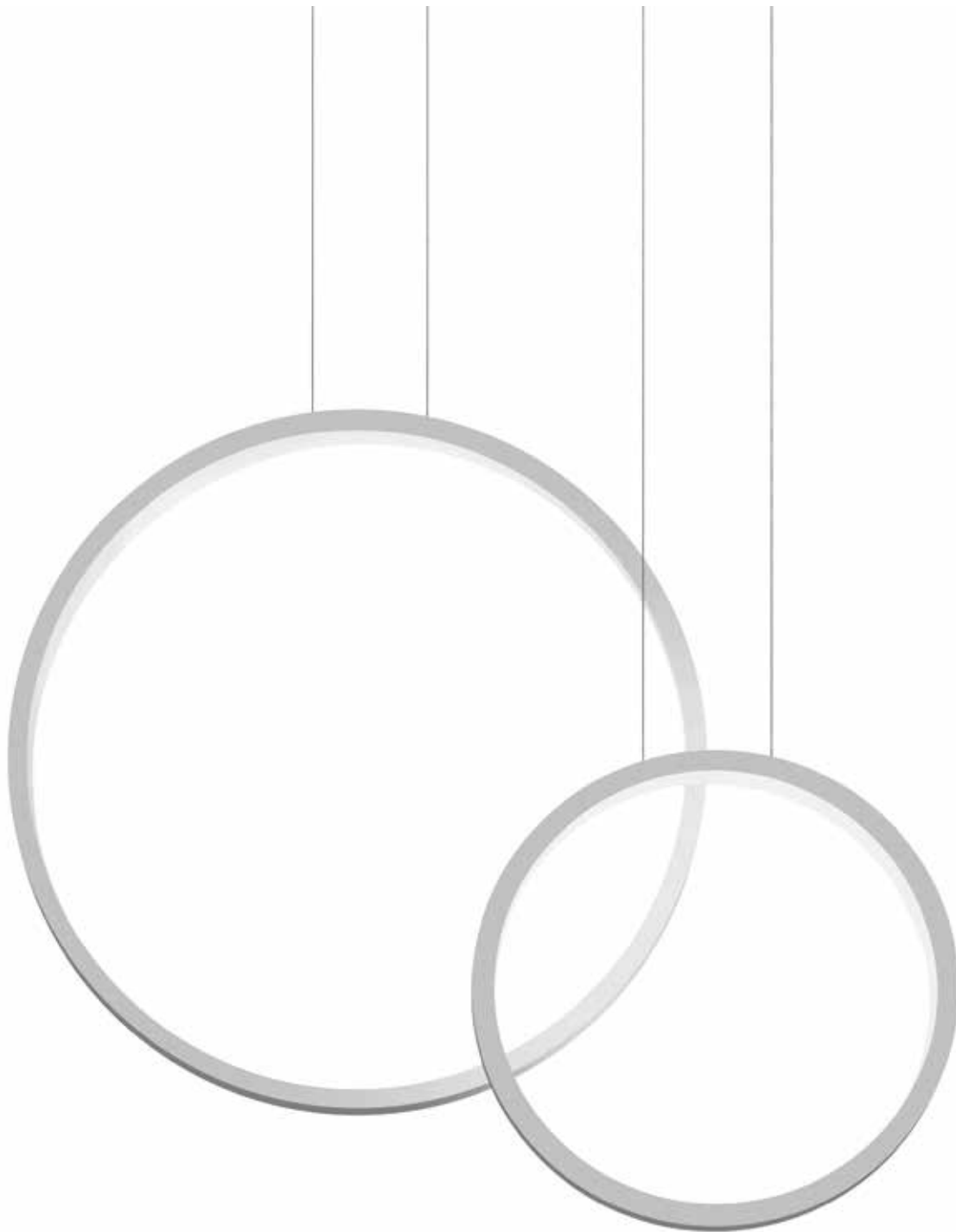



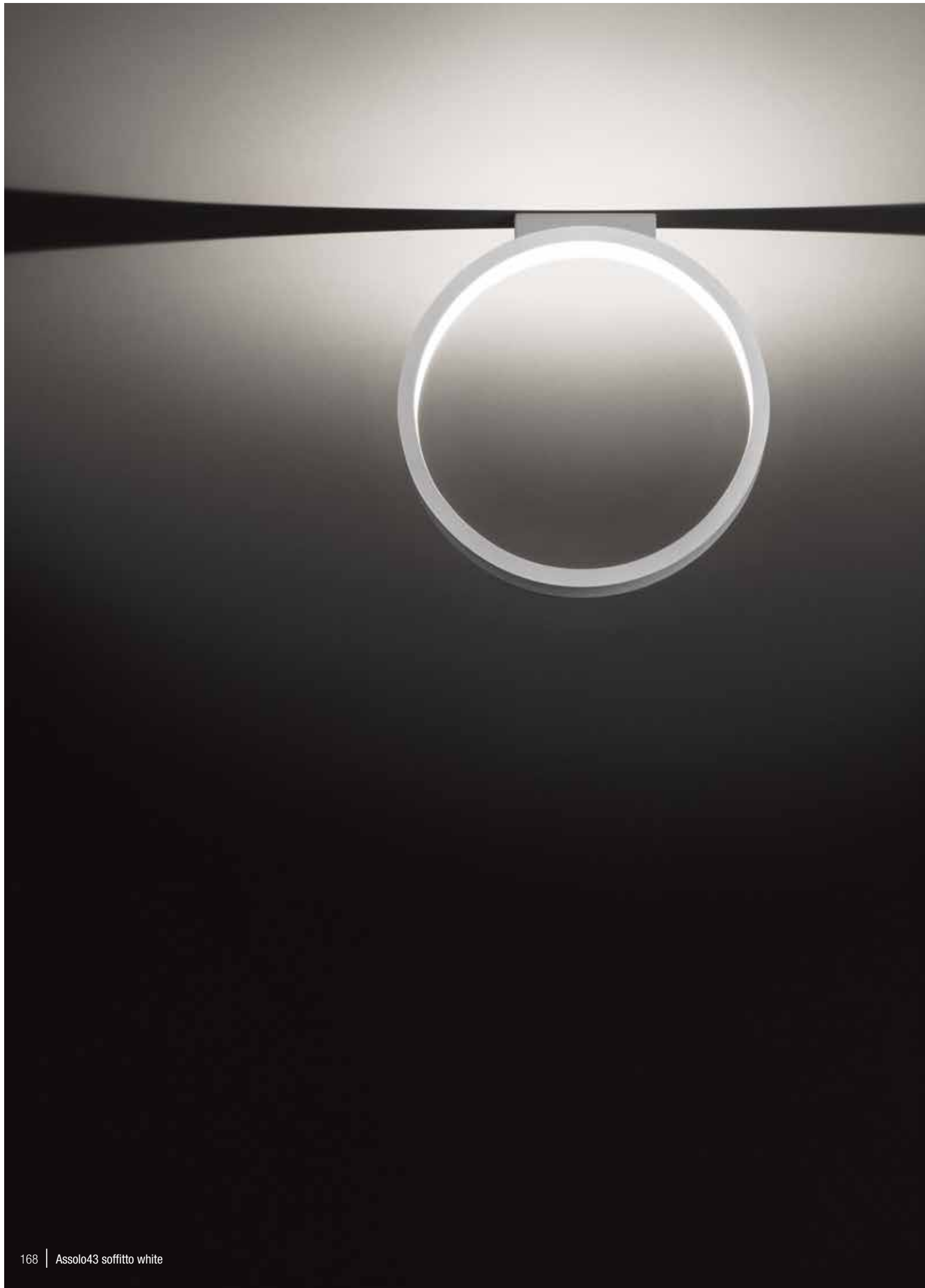

Assolo43 / Assolo70

Luta Bettonica, 2013



Assolo43 appoggio / Assolo70 terra

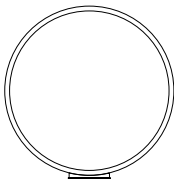

Ø 43/70 cm
Ø 17/27^{9/16"}

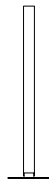

17,5 cm
6^{7/8"}

45/72 cm
17^{39/28^{5/16"}}



bianco / white / weiß / blanc / blanco



nero / black / schwarz / noir / negro



oro opaco / matt gold / Gold matt / or mat / oro mate

light control available:



phase cut dimmable (no Assolo70 terra, Assolo43 appoggio)



in line dimmer (only Assolo70 terra, Assolo43 appoggio)

Assolo43 / Assolo70 sospesa

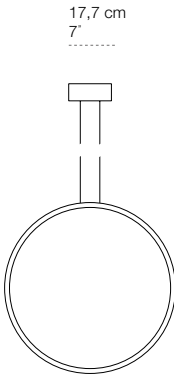

Ø 43/70 cm
Ø 17/27^{9/16"}

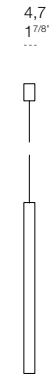

4,5 cm
1^{3/4"}

7 cm
2^{5/8"}

max 400 cm
157^{1/2"}

light emission available:

luce indiretta / indirect light / indirektes Licht / lumière indirecte / luz indirecta

led 27W / 2.900 lm / 2.700K / CRI92

Assolo43 / Assolo70 soffitto

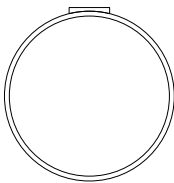

Ø 43/70 cm
Ø 17/27^{9/16"}



4,5 cm
1^{3/4"}

45/72 cm
17^{39/28^{5/16"}}



Assolo parete | soffitto / Assolo appoggio

Lampade dimmerabili per interni a luce indiretta della famiglia Assolo, diametro 21 cm, caratterizzate dalle suggestive sottolineature di luce e dal design compatto e lineare, disponibili in versione parete, plafone e appoggio. In finitura bianco, nero e oro opaco valorizzano l'ambiente con essenzialità e raffinatezza.

An indoor luminaire with dimmer for indirect light from the Assolo family, featuring the evocative stress of light and a compact linear design, available in wall, ceiling and tabletop versions and with a 21 cm diameter. The matt gold, black and white finishes add a touch of essential simplicity and refinement to every interior.

Dimmbare Leuchten der Familie Assolo für den Innenbereich mit indirekter Lichtausgabe, Durchmesser 21 cm, die sich durch suggestive Lichtakzente und ein kompaktes, lineares Design auszeichnen. Erhältlich als Wand-, Decken- oder Tischleuchtenausführung. In den Ausführungen Weiß, Schwarz und Mattgold erhältlich, verleihen sie ihrer Umgebung schlichte Eleganz und Raffinesse.

Lampes d'intérieur dimmables à lumière indirecte de la famille Assolo, d'un diamètre de 21 cm, caractérisées par des saisissants jeux de lumière, au design compact et linéaire, disponibles en versions mur, plafond et à poser. Dans les finitions blanc, noir et or mat, ils valorisent la pièce avec simplicité et raffinement.

De la familia Assolo, estas lámparas regulables para interiores, de luz indirecta, de 21 cm de diámetro, se caracterizan por sus sugestivos realces de luz y por su diseño compacto y lineal. Disponibles en versión de pared, de techo y de apoyo. Con acabados blanco, negro y dorado mate valorizan el ambiente con esencialidad y elegancia.









Assolo parete | soffitto / Assolo appoggio

Luta Bettonica, 2013



Assolo appoggio

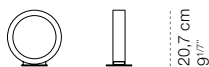

Ø 20 cm
Ø 7^{7/8}"

9,5 cm
3^{3/4}"

20,7 cm
8^{1/7}"

 bianco / white / weiß / blanc / blanco

 nero / black / schwarz / noir / negro

 oro opaco / matt gold / Gold matt / or mat / oro mate

Assolo parete | soffitto





20,4 cm
8"

4,5 cm
1^{3/4}"

Ø 20 cm
Ø 7^{7/8}"

light control available:

 on-off (only Assolo parete | soffitto)

 phase cut dimmable (only Assolo parete | soffitto)

 integrated touch dimmer (only Assolo appoggio)

Assolo parete | soffitto piastra tonda

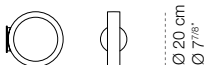

20,4 cm
8"

9,2 cm
3^{5/8}"

Ø 20 cm
Ø 7^{7/8}"

light emission available:

luce indiretta / indirect light / indirektes Licht / lumière indirecte / luz indirecta

ASSOLO APPOGGIO
led 10W / 1.000 lm / 2.700K / CRI80

ASSOLO Parete | soffitto
led 16W / 1.300 lm / 2.700K / CRI80

Assolo outdoor

Lampada da parete e plafone per esterni a luce indiretta della famiglia Assolo, diametro 21cm, con le suggestive sottolineature di luce che caratterizzano tutta la famiglia, arreda con essenzialità e raffinatezza. Disponibile in finitura bianco opaco e antracite metallizzato, può essere esposta a qualsiasi agente atmosferico.

An outdoor wall and ceiling lamp for indirect light from the Assolo family, featuring the evocative stress of light characteristic of the entire family and a 21 cm diameter, ideal for an essentially simple, refined décor. Available with a matt white or metallic anthracite finish, it can be exposed to any atmospheric conditions.

Wand- und Deckenleuchte der Familie Assolo für den Außenbereich mit indirekter Lichtausgabe, Durchmesser 21 cm, die sich wie alle Modelle dieser Familie durch suggestive Lichtakzente auszeichnet. Verleiht ihrer Umgebung schlichte Eleganz und Raffinesse. In den Ausführungen Mattweiß und Metallic-Anthrazit erhältlich, hält sie jeglichen Witterungsbedingungen stand.

Lampe d'extérieur de mur et de plafond à lumière indirecte de la famille Assolo d'un diamètre de 21 cm, avec des extraordinaires accentuations de lumière qui caractérisent toute la famille, décore avec simplicité et raffinement. Disponible dans les finitions en blanc mat et anthracite métallique; il peut être exposé à tout agent atmosphérique.

De la familia Assolo, esta lámpara de pared y de techo, de luz indirecta, de 21 cm de diámetro, diseñada para exteriores, propone los sugestivos realces de luz que caracterizan a toda la familia. Decora con esencialidad y elegancia. Disponible en acabado blanco mate y antracita metalizado. Puede quedar expuesta a cualquier agente atmosférico.

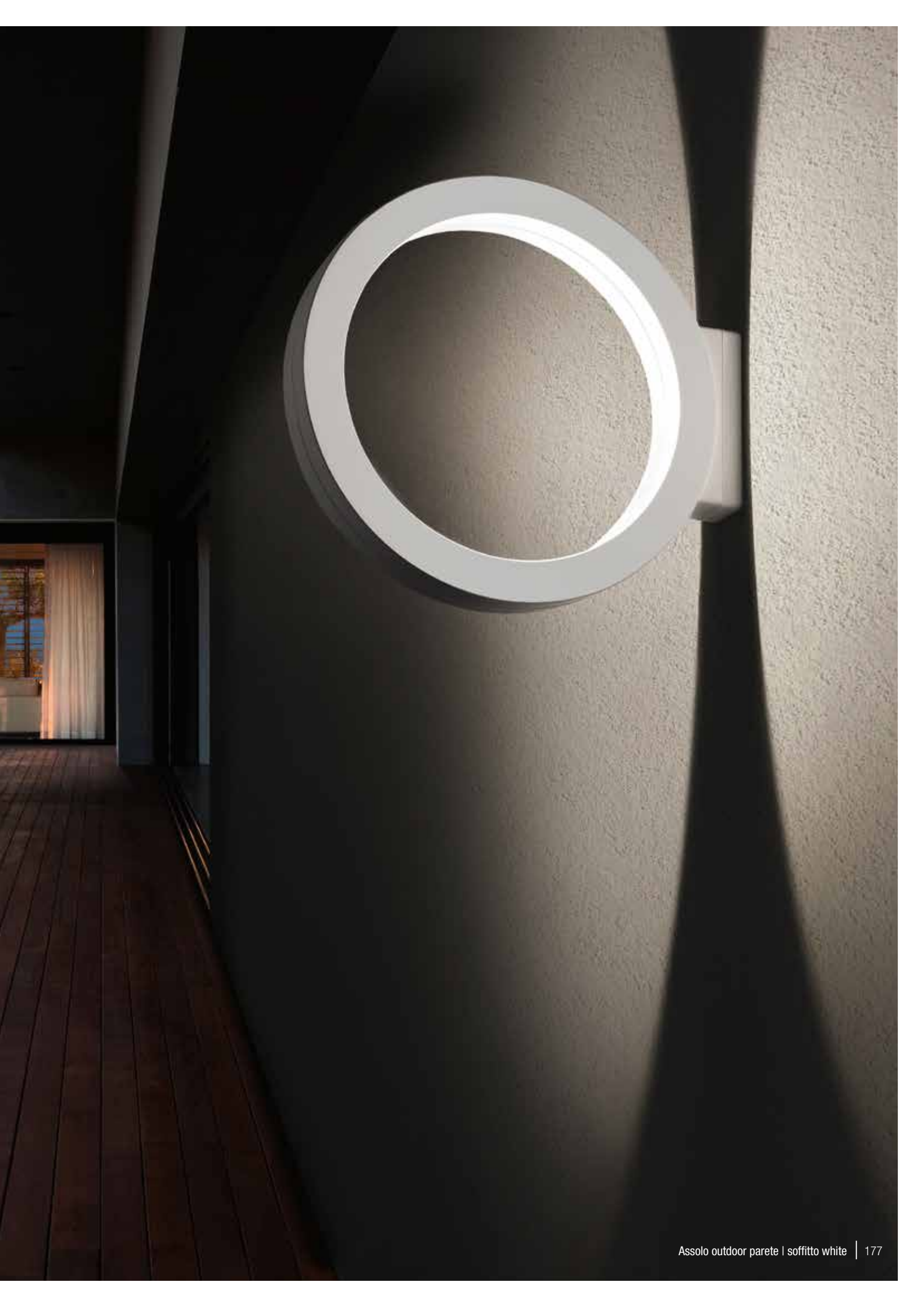



Design | Esterni

Assolo outdoor

Luta Bettonica, 2013



22 cm
8^{5/8}"



4,5 cm
1^{3/4}"

Ø 20 cm
Ø 7^{7/8}"



bianco / white / weiß / blanc / blanco



antracite metallizzato / metallized anthracite / anthrazitgrau metallisiert /
anthracite métallisé / antracita metalizado

light control available:

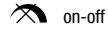

on-off

light emission available:

luce indiretta / indirect light / indirektes Licht / lumière indirecte / luz indirecta

led 15W / 1.200 lm / 2.700K / CRI95

protection rating:

IP65

Design | Interni

FormaLa

Lata Bettonica, 2015



FormaLa, un nastro di luce in acciaio armonico modellabile in infinite configurazioni: linee curve, simmetriche, asimmetriche, aperte e chiuse. Lampada da parete e plafone per interni a luce diretta e indiretta, dimmerabile da comandi di tipo tradizionale e vocale. Disponibile in quattro lunghezze, due colori e con alimentatore integrato o remoto. E' disponibile inoltre l'accessorio diffusore, realizzato da un sottile foglio di policarbonato opalescente serigrafato argento per coprire i led e ammorbidire la luce. La famiglia delle lampade FormaLa è coperta da Brevetto di invenzione.

A ribbon of light made of harmonic steel that can be positioned in an infinite variety of configurations: straight or curved lines, symmetric and asymmetric, open or closed, FormaLa is a wall and ceiling lamp for interiors with direct or indirect lighting that can be dimmed using traditional controls or voice commands. Available in four lengths, two colours and with a built-in or remote power supply, it can also come with a diffuser accessory, comprising a thin sheet of silver screen-printed opalescent polycarbonate to cover the led sources and soften the light. The FormaLa family of luminaires is protected by a patent.

FormaLa erzeugt ein Lichtband aus Federstahl, das sich mit unendlich vielen Konfigurationsmöglichkeiten formen lässt: in gewundenen, symmetrischen, asymmetrischen, offenen oder geschlossen Linien. Wand- und Deckenleuchte für den Innenbereich mit Direkt- und Indirektlicht, dimmbar über herkömmliche Regler und per Sprachsteuerung. Erhältlich in vier Längen, zwei Farben und mit eingebauter oder fern installierbarer Speiseeinheit. Als Zubehör ist ein Lichtverteiler erhältlich, der in einer dünnen Platte aus opaleszierendem Polycarbonat mit silbernem Siebdruck besteht und die LED-Leuchtmittel abdeckt sowie das Licht weicher macht. Die Familie der FormaLa Leuchten steht unter Patentschutz.

FormaLa, un ruban de lumière en acier harmonique, modulable dans des combinaisons infinies: lignes courbes, symétriques, asymétriques, ouvertes et fermées. Lampe d'intérieur, de mur et de plafond, à lumière directe et indirecte, réglable par des appareils de commande traditionnels et par contrôle vocal. Disponible en quatre longueurs, deux couleurs et avec alimentation intégrée ou à distance. Un accessoire diffuseur est également disponible. Il est composé d'une fine feuille de polycarbonate opalescent sérigraphié argent qui couvre les led et adoucit la lumière. La famille des lampes FormaLa est protégée par un Brevet d'invention.

FormaLa, una cinta de luz de acero armónico, modelable en infinitas configuraciones: líneas curvas, simétricas, asimétricas, abiertas y cerradas. Lámpara de pared y de techo para interiores, de luz directa e indirecta, regulable con control de tipo tradicional y vocal. Disponible en cuatro largos, dos colores y con alimentador integrado o remoto. Está disponible también el accesorio difusor, formado por una delgada hoja de policarbonato opalescente serigrafiada color plateado para cubrir los leds y atenuar la luz. La familia de las lámparas FormaLa está protegida por Patente de invención.





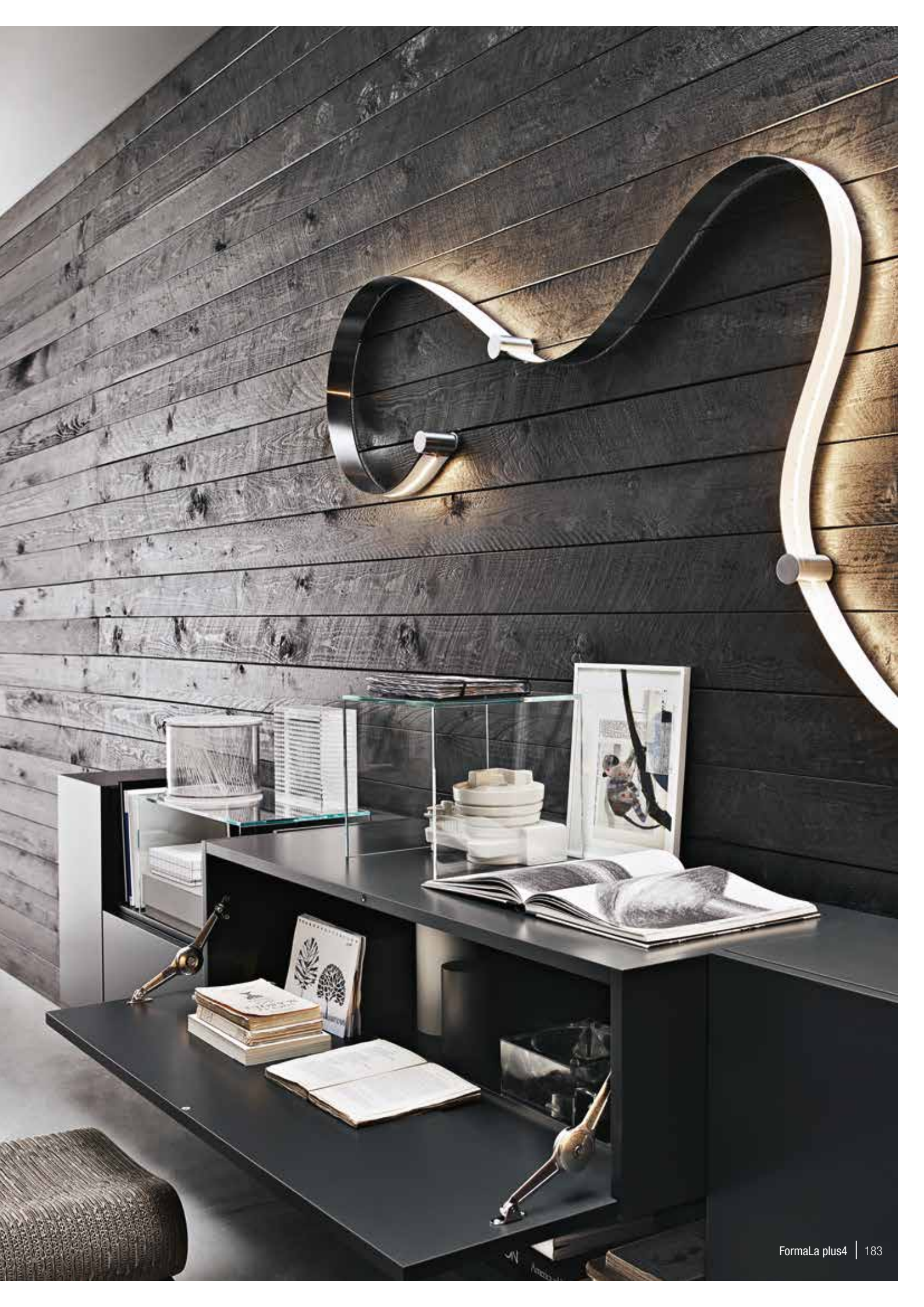







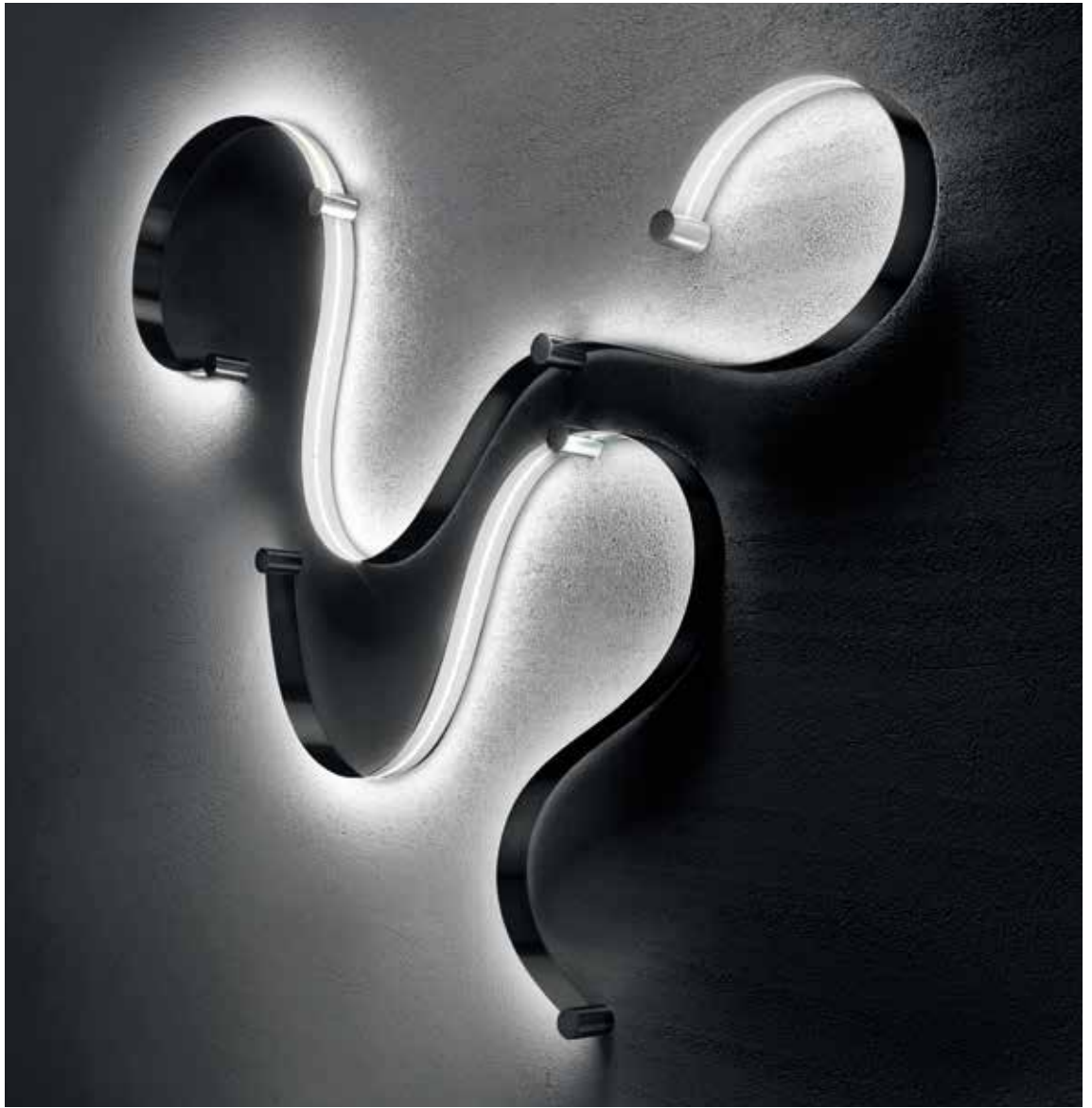

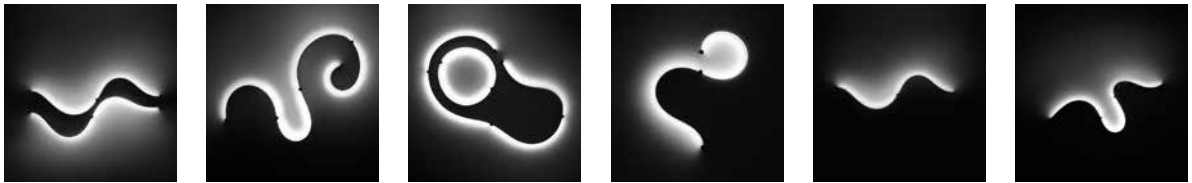
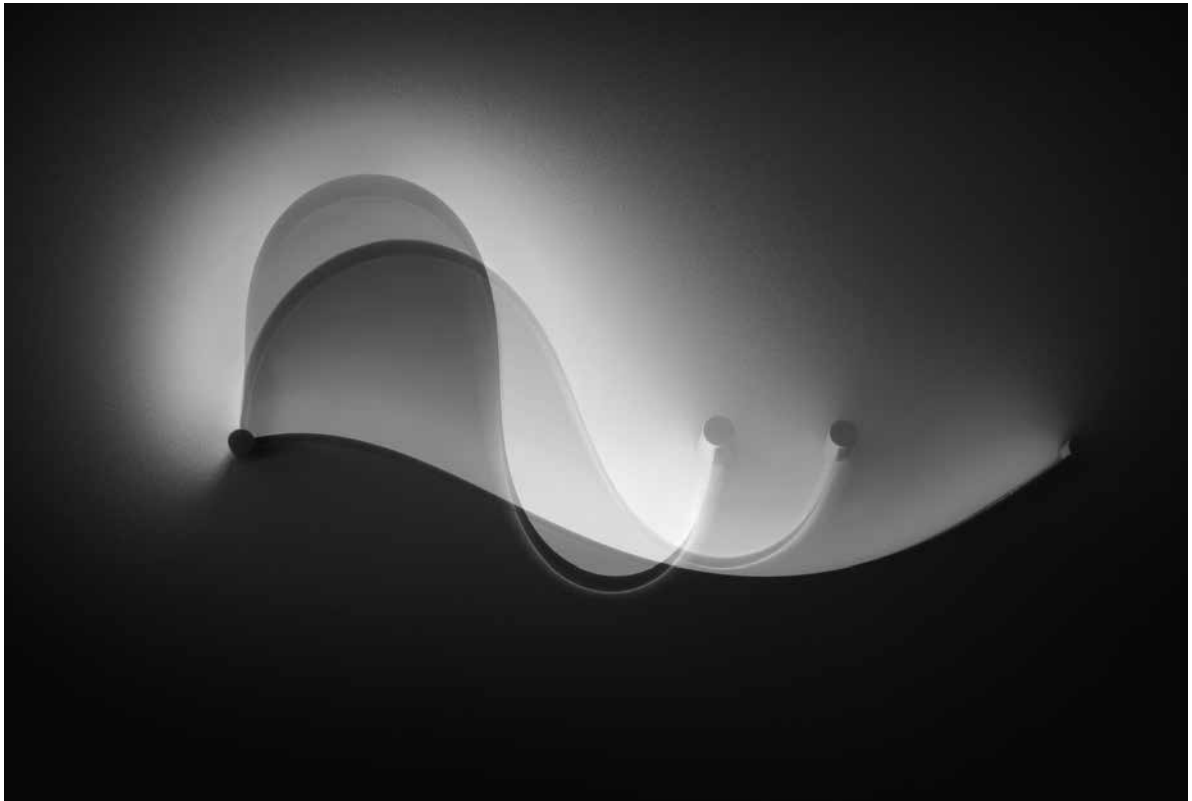

Finitura acciaio satinato e nero / brushed steel and black finish / Ausführung Stahl satiniert und schwarz / finition acier satiné et noir / acabado acero satinado y negro

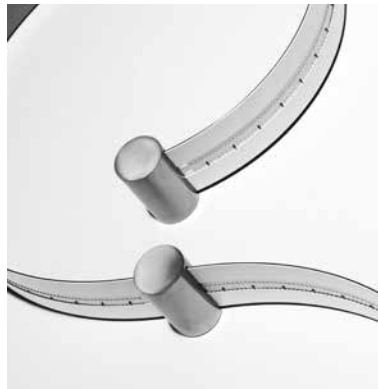

Finitura acciaio satinato e bianco / brushed steel and white finish / Ausführung Stahl satiniert und weiß / finition acier satiné et blanc / acabado acero satinado y blanco



Diffusore in policarbonato serigrafato argento / diffusor in silver polycarbonate / diffusor aus silberfarbener Polykarbonatfolie / diffusor en polycarbonate en couleur argent / difusor en policarbonato de color plata

configurazioni / configurations / Gestaltungsformen / configurations / configuraciones

cinienils.com configurazioni consigliate, ingombri e dime per l'installazione / recommended solutions, outlines and templates for installation / Empfohlene Gestaltungsvorschlägen, Platzbedarf und Schablone für die Installation / configurations conseillées, mesures et modèles pour l'installation / configuraciones recomendadas, medidas y patrón para la instalación

FormaLa

Luta Bettonica, 2013



FormaLa parete | soffitto

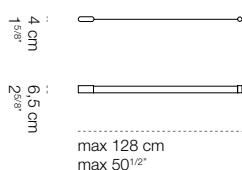

FormaLa2 parete | soffitto

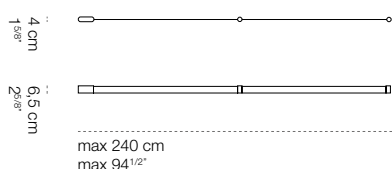

FormaLa plus1 parete | soffitto

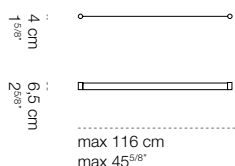

FormaLa plus2 parete | soffitto

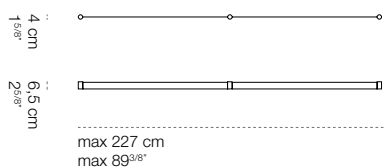

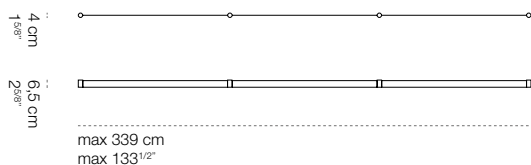

FormaLa plus3 parete | soffitto

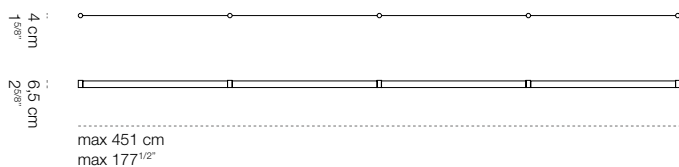

FormaLa plus4 parete | soffitto



 acciaio satinato-bianco / satined steel-white / satiniertes Stahl-weiß / acier satiné-blanc / acero satinado-blanco

 acciaio satinato-nero / satined steel-black / satiniertes Stahl-schwarz / acier satiné-noir / acero satinado-negro

light control available:

 phase cut dimmable (only FormaLa, FormaLa2)

 push dimmable (only FormaLa plus1, plus2, plus3, plus4)

 dali (only FormaLa plus1, plus2, plus3, plus4)

light emission available:

luce indiretta e diffusa / indirect and diffused light / indirektes und diffuses Licht / lumière indirecte et diffuse / luz indirecta y difusa

FORMALA, FORMALA PLUS1
led strip 24W / 2.200 lm / 2.700K / CRI90

FORMALA2, FORMALA PLUS2
led strip 2x24W / 2x2.200 lm / 2.700K / CRI90

FORMALA PLUS3
led strip 3x24W / 3x2.200 lm / 2.700K / CRI90

FORMALA PLUS4
led strip 4x24W / 4x2.200 lm / 2.700K / CRI90

Design | Interni

Sestessa

Lata Bettonica, Mario Melocchi, 2009-2015



Sestessa / Sestessina / Sestessa maxi

Lampade da parete per interni a luce indiretta e riflessa della famiglia Sestessa. Caratterizzate dalla gradinatura e dalla sinuosità della forma, sono disponibili in versione on-off e dimmerabile da comandi tradizionali e Casambi.

A wall lamp for interiors with indirect and reflected light from the Sestessa family, featuring a stepped, sinuous shape and available in an on-off version and with traditional dimming controls and Casambi.

Wandleuchten der Familie Sestessa für den Innenbereich mit indirekter und reflektierter Lichtausgabe. Die Besonderheit dieser Leuchten ist der Reichtum ihrer abgestuften und geschwungenen Formen. Erhältlich als Ein/Aus-Version sowie mit Dimmbarkeit über herkömmliche Regler und mittels CASAMBI-Lichtsteuerung.

Lampes d'intérieur de mur pour une lumière indirecte et réfléchie de la famille Sestessa. Caractérisées par une structure à gradins et une forme sinueuse, elles sont disponibles en version on-off et dimmables à l'aide des commandes traditionnelles et de Casambi.

Lámparas de pared para interiores de luz indirecta y refleja, de la familia Sestessa. Se caracterizan por su superficie escalonada y la sinuosidad de sus formas; están disponibles en versión on/off y regulables con control tradicional y Casambi.









Sestessa / Sestessina / Sestessa maxi

Luta Bettonica, Mario Melocchi, 2009-2013



Sestessina

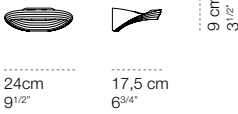

Sestessa

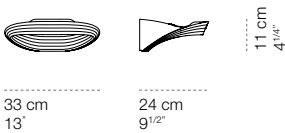

Sestessa Maxi

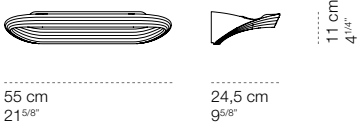

 bianco / white / weiß / blanc / blanco

light control available:

 on-off (only Sestessa led, Sestessina led)

 phase cut dimmable

 casambi integrated (no Sestessa alogena, Sestessina alogena)

light emission available:

luce indiretta / indirect light / indirektes Licht / lumière indirecte / luz indirecta

SESTESSA LED

led 20W / 2.900 lm / 2.700K / CRI80
led 20W / 1.850 lm / 2.700K / CRI95

SESTESSINA LED

led 20W / 2.000 lm / 2.700K / CRI80
led 20W / 1.700 lm / 2.700K / CRI95

SESTESSA MAXI LED

led 39W / 5.000 lm / 2.700K / CRI80
led 39W / 3.300 lm / 2.700K / CRI95

Sestessa terra

Lampada dimmerabile da terra per interni a luce indiretta e riflessa della famiglia Sestessa. Caratterizzata dalla gradinatura e dalla sinuosità della forma, è disponibile con dimmer rompifilo.

A floor lamp for interiors with indirect and reflected light from the Sestessa family, featuring a stepped, sinuous shape and available with a wire-break dimmer.

Dimmbare Stehleuchte der Familie Sestessa für den Innenbereich mit indirekter und reflektierter Lichtausgabe. Zeichnet sich aus durch ihre prägnant abgestufte und geschwungene Form. Inline-Dimmer erhältlich.

Lampadaire d'intérieur dimmable à lumière indirecte et réfléchie de la famille Sestessa, caractérisée par une structure à gradins et une forme sinueuse, est disponible avec gradateurs à rupture de fil.

Lámpara regulable de pie para interiores, de luz indirecta y refleja de la familia Sestessa. Se caracteriza por su superficie escalonada y la sinuosidad de su forma; está disponible con dimmer de pie.





Design | Interni

Sestessa terra

Luta Bettonica, Mario Melocchi, 2009-2015

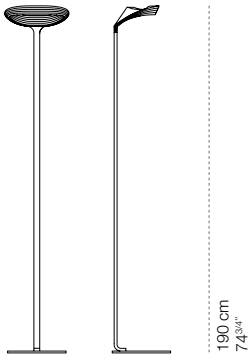

33 cm
13"

Ø 30 cm
Ø 11 3/4"

190 cm
74 3/8"

 bianco / white / weiß / blanc / blanco

light control available:

 in line dimmer

light emission available:

luce diffusa e indiretta / indirect and diffused light / diffuses und indirektes Licht /
lumière diffuse et indirecte / luz difusa e indirecta

SESTESSA TERRA LED

led 39W / 3.900 lm / 2.700K / CRI80

led 39W / 2.850 lm / 2.700K / CRI95

Sestessa sospesa / Sestessa cabrio / Sestessa plafone / Sestessa semincasso

Lampade per interni, dimmerabili da comandi tradizionali e Casambi della famiglia Sestessa. Caratterizzate dalla gradinata e dalla sinuosità della forma, Sestessa plafone, semincasso e sospesa emettono esclusivamente luce riflessa, mentre la versione cabrio permette la doppia emissione luminosa: indiretta verso l'alto, riflessa verso il basso.

Lamps for interiors from the Sestessa family, featuring a stepped, sinuous shape, the Sestessa ceiling, semi-built-in and suspension lamps emit reflected light only, while the convertible cabrio version also allows for a twin light emission: indirect upwards and reflected downwards.

Leuchten der Familie Sestessa für den Innenbereich, dimmbar über herkömmliche Regler und mittels CASAMBI-Lichtsteuerung. Gekennzeichnet durch ihre prägnant abgestufte und geschwungene Form, geben die Sestessa plafone (Deckenleuchte), semincasso (halb versenkte Einbauleuchte) und sospesa (Hängeleuchte) nur reflektiertes Licht aus, während die Version cabrio eine zweifache Lichtausgabe bietet: indirekt nach oben, reflektiert nach unten.

Lampes d'intérieur, dimmables à l'aide d'appareils de commande traditionnels et de Casambi, de la famille Sestessa. Caractérisées par une structure à gradins et une forme sinueuse, Sestessa, plafone, semincasso et sospesa, n'émet que de la lumière réfléchie, tandis que la version cabrio permet la double émission lumineuse: indirecte vers le haut, réfléchie vers le bas.

Lámparas para interiores de la familia Sestessa, regulables en intensidad con controles tradicionales y Casambi. Se caracterizan por su superficie escalonada y la sinuosidad de sus formas. Sestessa plafone, semincasso y sospesa emiten exclusivamente luz refleja, en cambio Sestessa cabrio permite la doble emisión luminosa: indirecta hacia arriba y refleja hacia abajo.







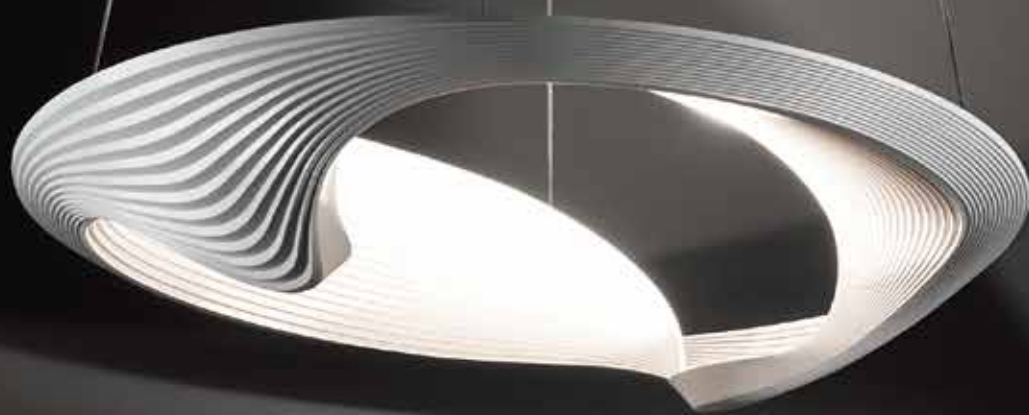

Sestessa sospesa / cabrio / plafone / semincasso

Luta Bettonica, Mario Melocchi, 2009-2015



Sestessa sospesa

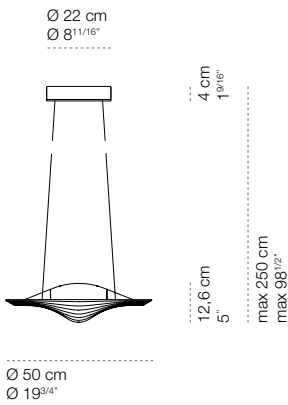

○ bianco / white / weiß / blanc / blanco

light control available:

☾ phase cut dimmable

▲ casambi integrated

light emission available:

luce indiretta / indirect light / indirektes Licht / lumière indirecte / luz indirecta

led 2x26W / 2x2.400 lm / 2.700K / CRI95

Sestessa cabrio

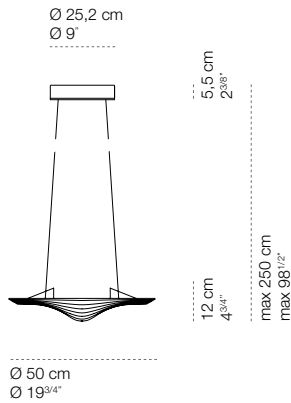

Sestessa plafone

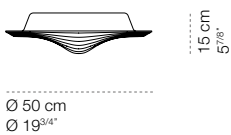

Sestessa semincasso

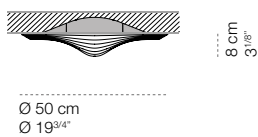

Design | Interni

Gradi

Franco Bettonica, Mario Melocchi, 1990



Gradi / Gradimini / microGradi

Lampade per interni dimmerabili da terra, parete e soffitto. Gradi è caratterizzata da un archetto in acciaio cromato o nichel satinato, e da un cilindro in vetro borosilicato trattato con smalti speciali che assolve da solo le diverse funzioni di riflettore, schermo antiabbagliante e protezione della lampada. Disponibile in versione retinato per luce indiretta; opalescente per luce indiretta e diffusa; tuttopallescete per luce diffusa.

An indoor floor, wall and ceiling lamp with dimmer, Gradi features a small arc made of chromed steel or brushed nickel and a cylinder made of borosilicate glass treated with special enamels that fulfils the various functions of reflector, anti-glare screen and bulb protection in just one element. Available in a cross-hatched (retinato) version for indirect light, opalescent for indirect and diffused light and full opalescent (tuttopallescete) for diffused light.

Dimmbare Steh-, Wand- und Deckenleuchten für den Innenbereich. Gradi zeichnet sich durch einen verchromten Stahl- oder satinierten Nickelbogen und einen mit Spezialglasuren behandelten Borosilikatglaszylinder aus, der die verschiedenen Funktionen als Reflektor, Blendschutz und Leuchtmittelschutz allein erfüllt. Erhältlich als Rasterausführung für Indirektlicht, opaleszierend für Indirekt- und Streulicht sowie tuttopallescete (komplett opaleszierend) für Streulicht.

Lampes d'intérieur, de terre, de mur et de plafond à intensité variable. Gradi se caractérise par un petit arc en acier chromé ou en nickel satiné et par un cylindre de verre de borosilicate traité avec des émaux spéciaux qui remplissent à eux seuls les différentes fonctions de réflecteur, d'écran antireflet et de protection de la lampe. Disponible en version tramé pour un éclairage indirect; opalescent pour une lumière indirecte et tuttopallescete pour une lumière diffuse.

Lámparas para interiores regulables en intensidad, de pie, de pared y de techo. Gradi se caracteriza por un semi-arco de acero cromado o níquel satinado, y por un cilindro de vidrio de borosilicato tratado con esmaltes especiales que por sí solo cumple las diferentes funciones de reflector, pantalla antideslumbrante y protección de la lámpara. Disponible en versión "retinato" para luz indirecta, "opalescente" para luz indirecta y difusa, "tuttopallescete" para luz difusa.















Gradi / Gradimini / microGradi

Franco Bettonica, Mario Melocchi, 1990-2016



Gradiparete

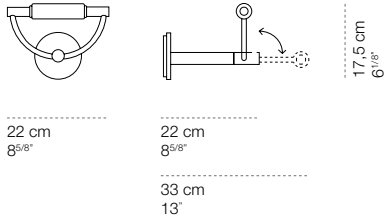

Gradiminiparete

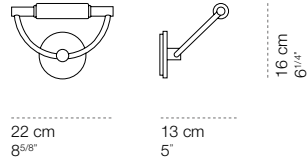

microGradiparete

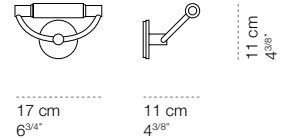

Gradisoffitto

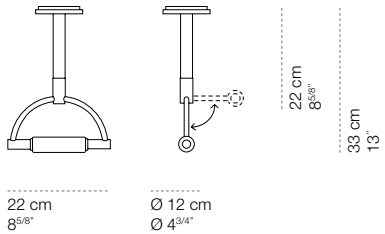

Gradiminisoffitto

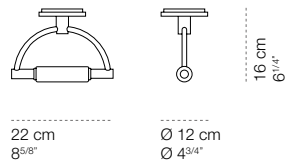

microGradisoffitto

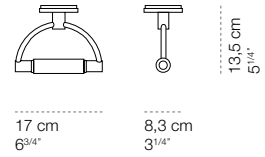

Graditerra

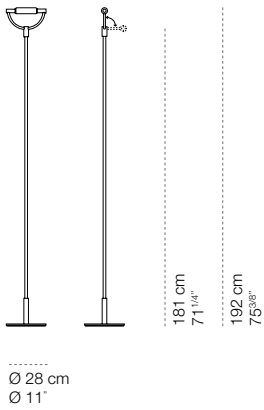

Gradiminiparete led

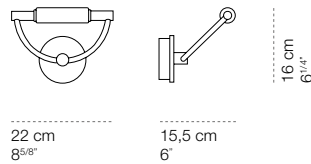

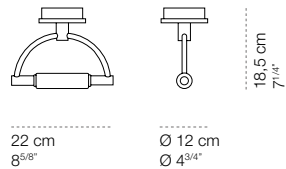

Gradiminisoffitto led

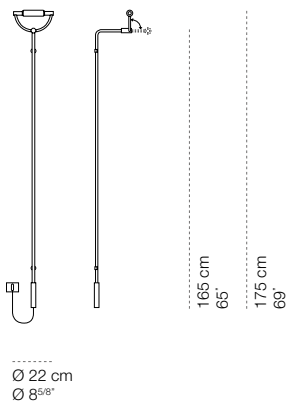

Gradiparete con stelo



 cromo / chrome / Chrom / chromé / cromo

 nichel satinato / satin nickel-plated / Nickel satiniert / nickel satiné / níquel satinado

glass diffuser available:

 retinato

 opalescente (no Graditerra, Gradiparete con stelo)

 tuttopalescente (no Graditerra, Gradiparete con stelo)

light control available:

 in line switch (only Gradiparete con stelo)

 phase cut dimmable (no Graditerra, Gradiparete con stelo)

 in line dimmer (only Graditerra)

light emission available:

retinato > luce indiretta / indirect light / indirektes Licht / lumière indirecte / luz indirecta

opalescente > luce indiretta e diffusa / indirect and diffused light / indirektes und diffuses Licht / lumière indirecte et diffuse / luz indirecta y difusa

tuttopalescente > luce diffusa / diffused light / diffuses Licht / lumière diffuse / luz difusa

GRADI

halo R7s HDG114,2 / 230W / 230V / 5.060 lm (bulb included)

GRADIMINI LED

led 2x6W / 2x750 lm / 2.700K / CRI80

GRADIMINI

halo R7s HDG114,2 / 120W / 230V / 2.450 lm (bulb included)

MICROGRADI

halo R7s HDG74,9 / 80W / 230V / 1.520 lm (bulb included)

Design | Interni

Convivio

Lata Bettonica, Mario Melocchi, 2005



Lampada sopratavolo per interni a luce diretta, dimmerabile da comandi tradizionali e Casambi. Convivio, una piccola sfera da cui nasce un cono di luce omogeneo che crea un mondo personale e intimo. Disponibile in versione led con lente trasparente nelle finiture cromo lucido o nero opaco.

A lamp for interiors, emitting direct light and designed to be suspended above the table, with traditional dimming controls and Casambi. Convivio is a small sphere that generates a cone of homogeneous light, creating an intimate, personal world. Available in a led version with a transparent lens with polished chrome or matt black finishes.

Tisch-Hängeleuchte für den Innenbereich mit Direktlichtausgabe, dimmbar über herkömmliche Regler und mittels CASAMBI-Lichtsteuerung. Convivio ist eine kleine Kugel, von der ein Kegel gleichmäßigen Lichts ausgeht, der eine vertrauliche Atmosphäre erzeugt. Erhältlich in den Ausführungen Glanzchrom oder Mattschwarz. Led-Version mit transparenter Linse.

Lampe d'intérieur à suspension sur table, à lumière directe, réglable à l'aide d'appareils de commande traditionnels et de Casambi. Convivio, une petite sphère qui génère un cône de lumière homogène, créant une ambiance personnelle et intime. Disponible en version led avec lentille transparente dans les finitions chrome poli ou noir mat.

Lámpara para interiores de luz directa, ideal para iluminar la mesa. Regulable en intensidad con controles tradicionales y Casambi. Convivio es una pequeña esfera de la que nace un cono de luz homogéneo que crea un mundo personal e íntimo. Disponible en versión led con lente transparente en los acabados cromo brillante o negro mate.



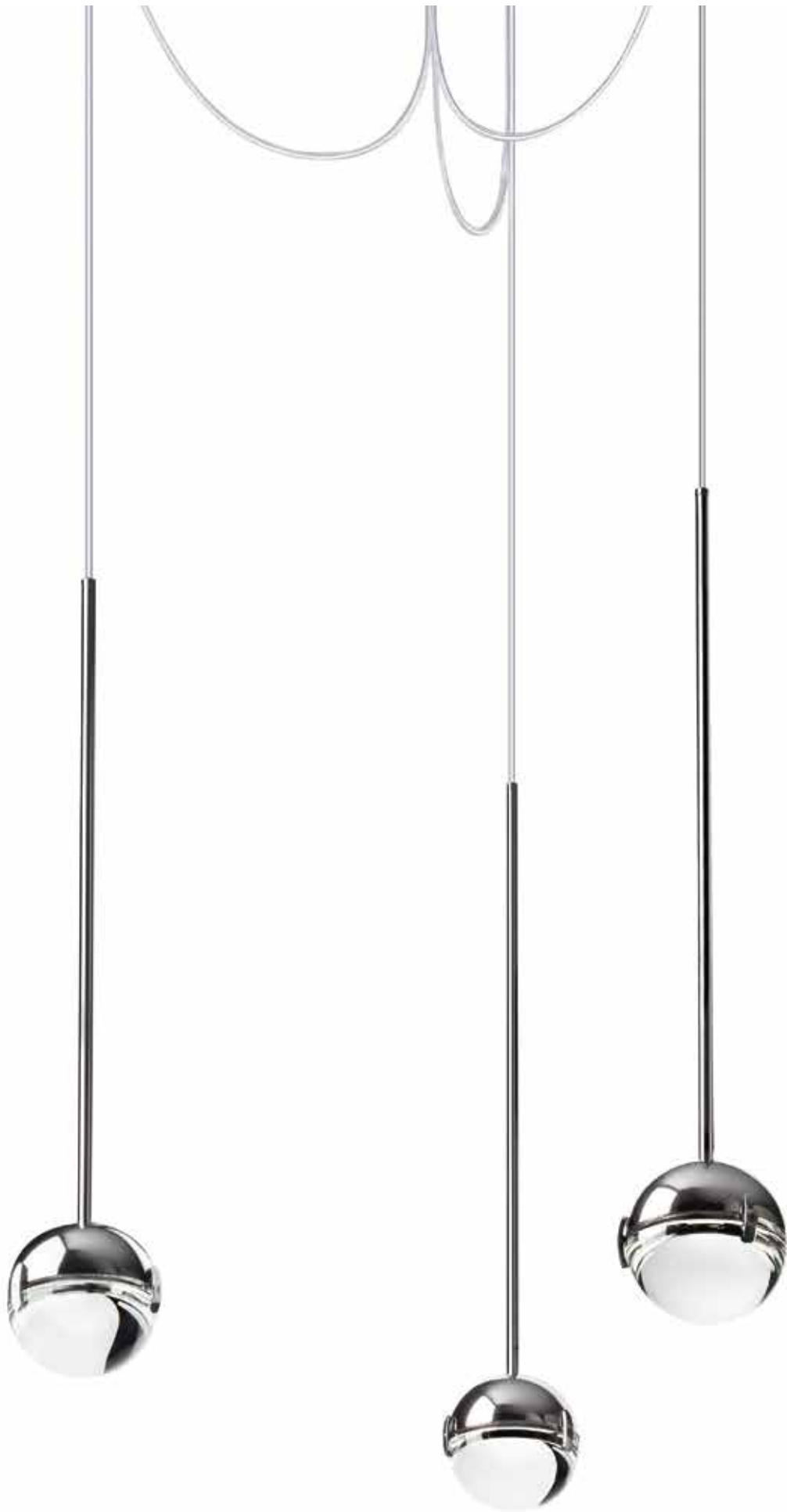



Convivio

Luta Bettonica, Mario Melocchi, 2005



Convivio new led sopratavolo

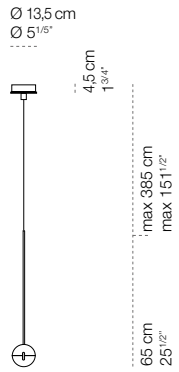

Ø 11 cm
Ø 4^{1/4}"

Convivio new led sopratavolo tre

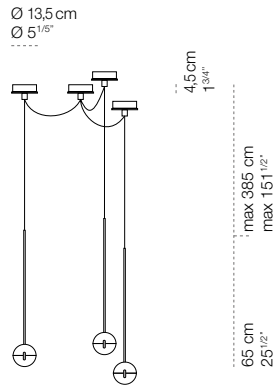

Ø 11 cm
Ø 4^{1/4}"

Convivio new led sopratavolo decentrata

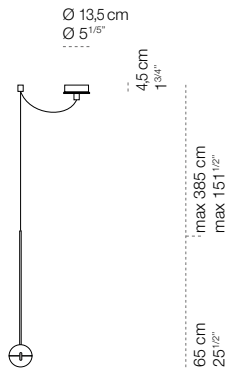

Ø 11 cm
Ø 4^{1/4}"

Convivio new led sopratavolo multipla

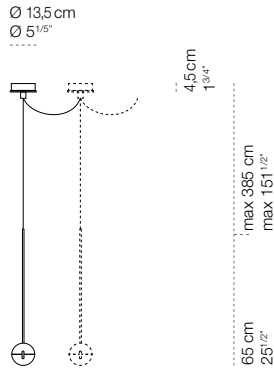

Ø 11 cm
Ø 4^{1/4}"

Convivio new led sopratavolo due

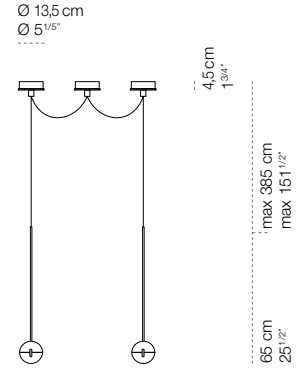

Ø 11 cm
Ø 4^{1/4}"

 cromo / chrome / Chrom / chromé / cromo

 nero opaco / matt black / Mattschwarz / noir mat / negro mate

lenses available:

 led > trasparente / transparent / transparent / transparent / transparente

light control available:

 phase cut dimmable

 casambi integrated

light emission available:

luce diretta localizzata / localised direct lighting / lokalisiertes direktes Licht /
éclairage localisé direct / iluminación localizada directa

CONVIVIO NEW LED

led 13W / 1.300 lm / 2.700K / CRI92

led 13W / 1.200 lm / dim to warm / CRI90

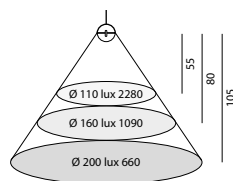

led light emission

Design | Interni

Componi200

Lata Bettonica, Luca and Mario Melocchi, 2009-2019



Famiglia di lampade con sorgente led attacco B15d, componibili con le sole mani, con rotazione del corpo illuminante su 360°. Disponibile nelle versioni da parete, soffitto, scrivania e terra, per un'illuminazione a luce bianca e/o colorata, diffusa, d'accento o mista.

A family of luminaires taking led sources with a B15d attachment and a lighting body that turns through 360°, which can be composed by hand and without any tools. Available in wall, ceiling, desktop and floor lamp versions for white and/or coloured, diffused, accent or mixed lighting.

Familie von Leuchten mit B15d led-Leuchtmittel. Mit bloßen Händen zusammensteckbar. Der Leuchtenkörper lässt sich um 360° frei ausrichten. Erhältlich als Wand-, Decken-, Schreibtisch- oder Stehleuchtenausführung. Bietet eine weiße und/oder farbige Lichtausgabe, Streulicht, Punktlicht oder gemischt.

Famille de lampes avec ampoule led B15d, peuvent être montés facilement à la main, avec rotation sur 360° du corps d'éclairage. Disponible en versions à mur, plafond, bureau et terre, pour un éclairage blanc et/ou coloré, diffus, d'accentuation ou mixte.

Familia de lámparas con fuente luminosa led, casquillo B15d, componibles usando solo las manos, con rotación del cuerpo iluminante de 360°. Disponible en las versiones de pared, de techo, de escritorio y de pie, para una iluminación de luz blanca y/o de color, difusa, de realce o mixta.











Componi200

Luta Bettonica, Luca and Mario Melocchi, 2009



Componi200
uno parete

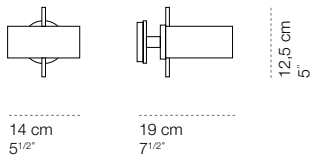

Componi200
due parete | soffitto 25

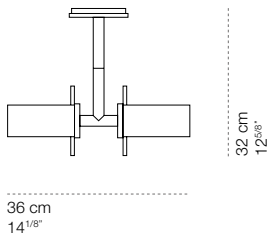

Componi200
uno soffitto 25

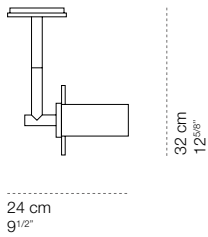

Componi200
ambiente&scrivania

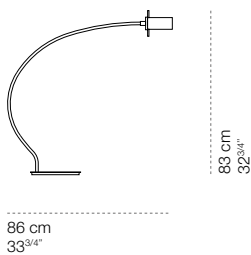

Componi200
lettura

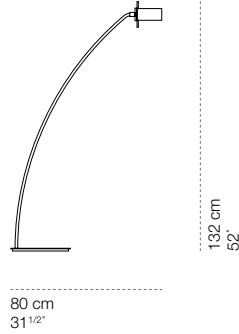

Componi200
curva

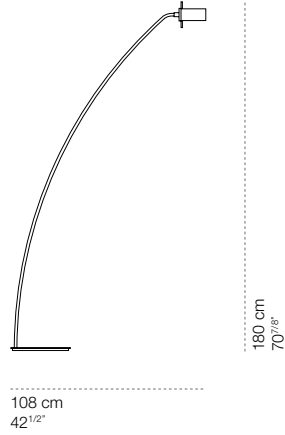

Componi200
mezzacurva

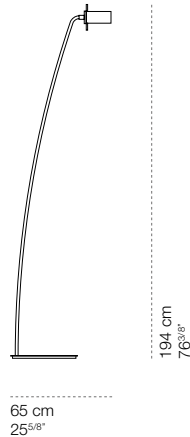

Componi200 anello



Componi200 disco



Componi200 lente



Componi200 struttura

 cromo / chrome / Chrom / chromé / cromo

 nichel satinato / satin nickel-plated / Nickel satiniert / nickelé satiné / níquel satinado

Componi200 anello

 retinato

 sfere nero / sfere black / sfere schwarz / sfere noir / sfere negro

 sfere bianco / sfere white / sfere weiß / sfere blanc / sfere blanco

Componi200 disco

 trasparente / transparent / transparent / transparent / transparente

 satinato / satin / satiniert / satiné / satinado

 opalescente quadrettato

 dicroico rosso / dichroic red / dichroitisch rot / dichroïque rouge / dicroico rojo

 dicroico giallo / dichroic yellow / dichroitisch gelb / dichroïque jaune / dicroico amarillo

 dicroico blu / dichroic blue / dichroitisch blau / dichroïque bleu / dicroico azul

Componi200 lente

 lente 105° > trasparente / transparent / transparent / transparent / transparente

 lente 70° > trasparente / transparent / transparent / transparent / transparente

light control available:

 phase cut dimmable (only Componi200 parete | soffitto)

 in line dimmer (only Componi200 ambiente&scrivania, lettura, curva, mezzacurva)

light emission available:

luce diretta, indiretta, diffusa, d'accento, o mista / direct, indirect, diffuse, accent or mixed lighting / streu-oder Punktlicht, indirekt, direkt oder gemischt / lumière directe, indirecte, diffuse, d'accent ou mixte / luz directa, indirecta, difusa, de realce o mixta

led B15d / bulb h max 9,5 cm ø max 5 cm (bulb not included)

Design | Interni

Componi75

Luta Bettonica, Luca and Mario Melocchi, 2009



Famiglia di lampade con sorgente attacco G9, componibili con le sole mani, con rotazione del corpo illuminante su 360°. Disponibile nelle versioni da parete e soffitto, per un'illuminazione a luce bianca e/o colorata, diffusa, d'accento o mista.

A family of luminaires taking the G9 light source attachment and a lighting body that turns through 360°, which can be composed by hand and without any tools. Available in wall and ceiling lamp versions, for white and/or coloured, diffused, accent or mixed lighting.

Familie von Leuchten mit G9-Fassung. Mit bloßen Händen zusammensteckbar. Der Leuchtenkörper lässt sich um 360° frei ausrichten. Erhältlich als Wand- und Deckenleuchtenausführung. Bietet eine weiße und/oder farbige Lichtausgabe, Streulicht, Punktlicht oder gemischt.

Famille de lampes avec ampoule led G9, peuvent être montés facilement à la main, avec rotation sur 360° du corps d'éclairage. Disponible en versions à mur, plafond pour un éclairage blanc et/ou coloré, diffus, d'accentuation ou mixte.

Familia de lámparas con fuente luminosa de casquillo G8, componibles usando solo las manos, con rotación del cuerpo iluminante de 360°. Disponible en las versiones de pared y de techo para una iluminación de luz blanca y/o de color, difusa, de realce o mixta.



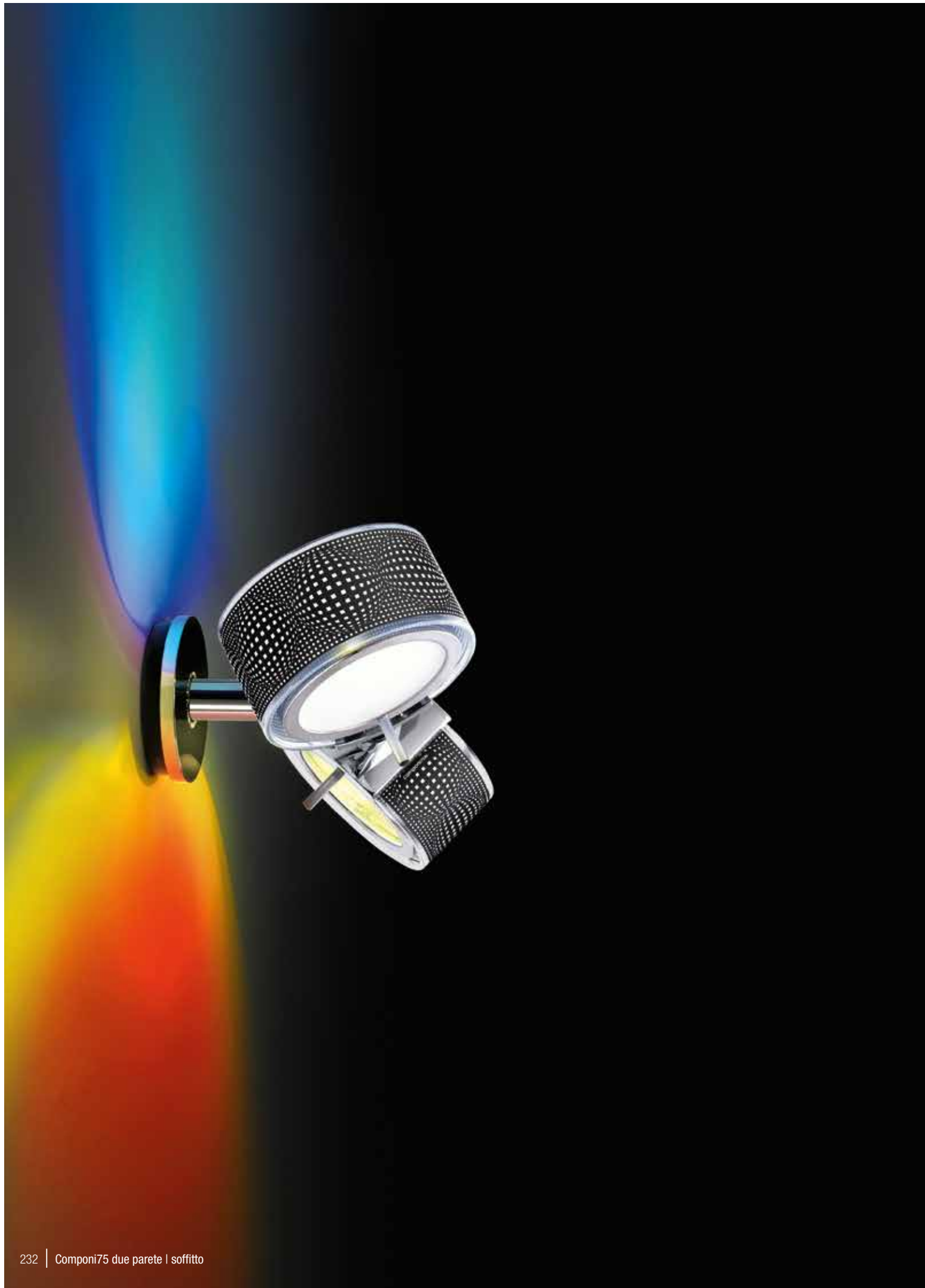



Componi75

Luta Bettonica, Luca and Mario Melocchi, 2009



Componi75 uno parete

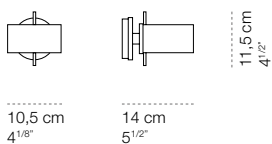

Componi75 due parete | soffitto

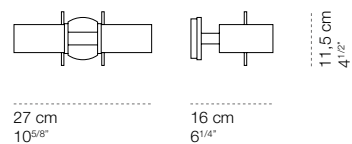

Componi75 due parete | soffitto 25

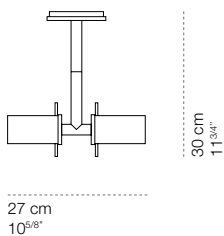

Componi75 anello





Componi75 disco







Componi75 lente









Componi75 struttura

-  cromo / chrome / Chrom / chromé / cromo
-  nichel satinato / satin nickel-plated / Nickel satiniert / nickelé satiné / níquel satinado

Componi75 anello

-  retinato
-  opalescente quadrettato
-  sfere nero / sfere black / sfere schwarz / sfere noir / sfere negro
-  sfere bianco / sfere white / sfere weiß / sfere blanc / sfere blanco

Componi75 disco

-  trasparente / transparent / transparent / transparent / transparente
-  satinato / satin / satiniert / satiné / satinado
-  opalescente quadrettato
-  dicroico rosso / dichroic red / dichroitisch rot / dichroïque rouge / dicroico rojo
-  dicroico giallo / dichroic yellow / dichroitisch gelb / dichroïque jaune / dicroico amarillo
-  dicroico blu / dichroic blue / dichroitisch blau / dichroïque bleu / dicroico azul

Componi75 lente

-  lente 80°> trasparente / transparent / transparent / transparent / transparente

light control available:

-  phase cut dimmable

light emission available:

luce diretta, indiretta, diffusa, d'accento, o mista / direct, indirect, diffuse, accent or mixed lighting / streu-oder Punktlicht, indirekt, direkt oder gemischt / lumière directe, indirecte, diffuse, d'accent ou mixte / luz directa, indirecta, difusa, de realce o mixta

led G9 3,5W / 230V / 400 lm / 2.700K (bulb(s) included)

Design | Interni

Tenso

Franco Bettonica, Mario Melocchi, 1994

TensoStilo

Luta Bettonica, 2016



TensoApparecchio led a tensione di rete senza alimentatore, su cavi a 230V, composto da un corpo illuminante a doppia emissione per un'illuminazione diretta e indiretta diffusa. Dalla forma essenziale e lineare TensoStilo è disponibile in finitura bianco e argento con diffusori in metacrilato opalescente. Apparecchio munito di TensoClic, connettore brevettato a perforazione d'isolante.

A led TensoLuminaire operating at mains voltage with no need for a transformer and mounted on 230V cables, comprising a twin-emission lighting body for direct and indirect diffused light. With its essentially simple, linear shape, TensoStilo is available in white and silver finishes with diffusers in opalescent methacrylate. This luminaire is fitted with TensoClic, the patented insulation-piercing connector.

Led-TensoLeuchte an 230V-Spannkabeln mit Netzspannung ohne Transformator. Besteht aus einem Leuchtenkörper mit zweifacher Lichtausgabe für Direkt- und Indirekt-/Streulicht. TensoStilo zeichnet sich durch die schlichte Eleganz seiner linearen Form aus und ist in den Ausführungen Weiß und Silber mit Lichtverteiltern aus opaleszierendem Methacrylat erhältlich. Mit TensoClic, dem patentierten, die Kabelisolierung durchdringenden Steckanschluss.

TensoAppareil led à tension de réseau sans transformateur, sur câbles à 230V, composée d'un corps d'éclairage à double émission pour un éclairage diffus direct et indirect. Avec une forme essentielle et linéaire, TensoStilo est disponible dans la finition blanc et argent avec diffuseurs en méthacrylate opalescent. Appareil muni de TensoClic, connecteur breveté à perforation d'isolant.

TensoAparato led con tensión de red sin alimentador, sobre cables de 230V, compuesto por un cuerpo iluminante de doble emisión para una iluminación directa e indirecta difusa. De forma esencial y lineal, TensoStilo está disponible en acabados blanco y plateado con difusores en metacrilato opalescente. Aparato provisto de TensoClic, conector patentado que perfora el aislante.

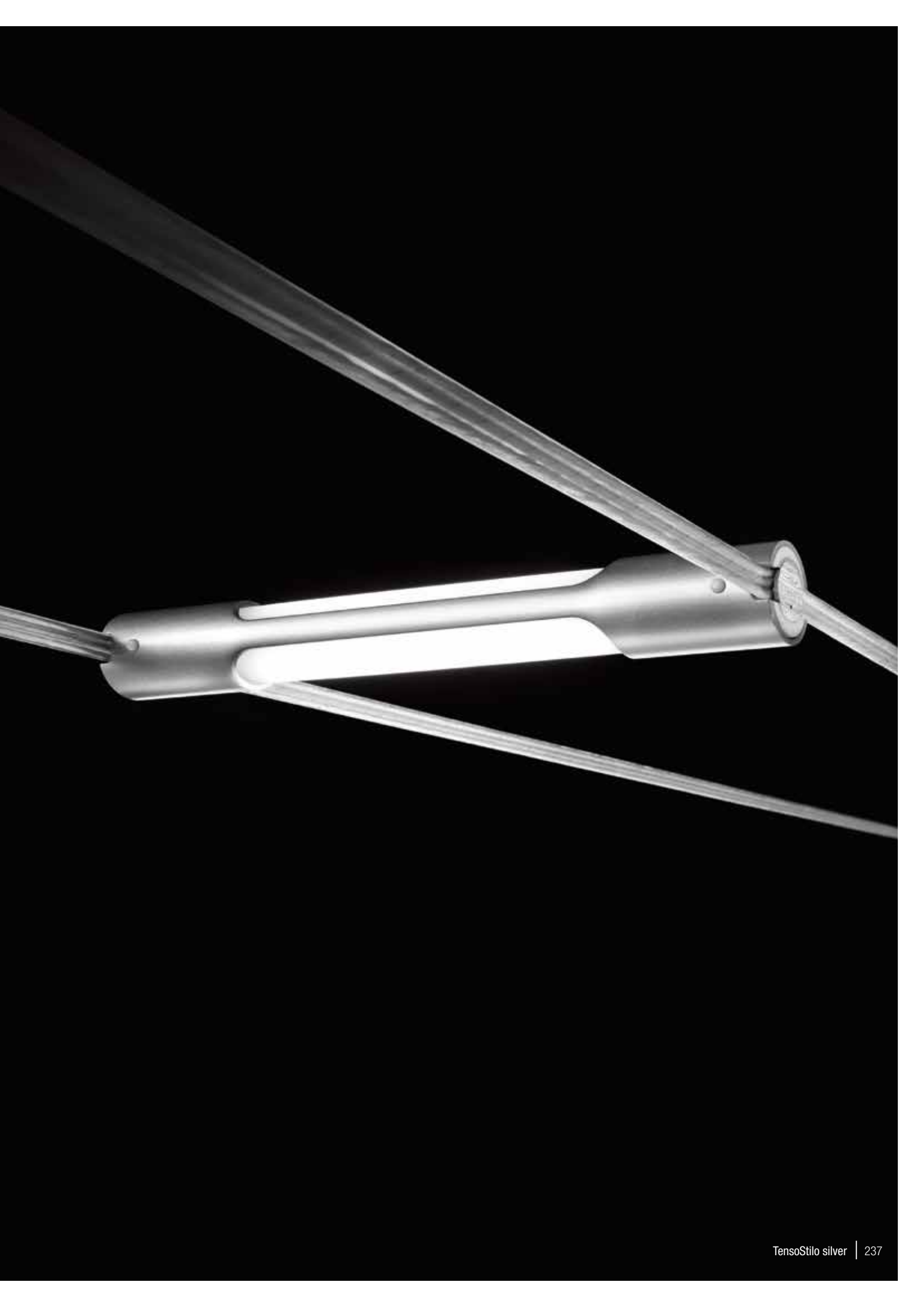



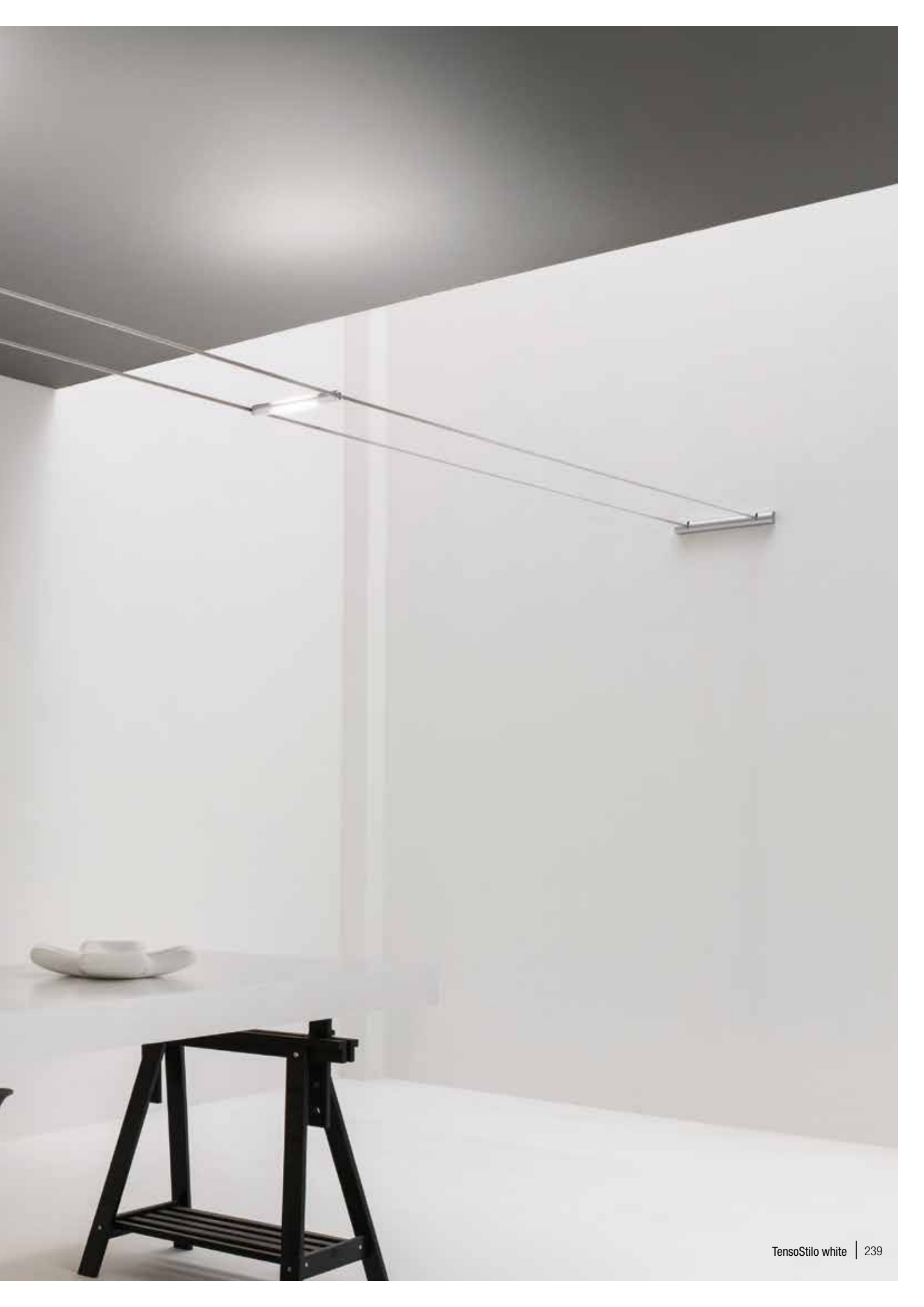







Design | Interni

TensoStilo

Luta Bettonica, 2016



29 cm
11^{3/8"}

Ø 3,5 cm
Ø 1^{3/8"}



bianco / white / weiß / blanc / blanco



argento / silver / Silber / argent / plateado

light control available:



on-off

light emission available:

luce diretta e indiretta diffusa / direct and indirect diffused light / lichtausgabe für Direkt- und Indirekt-Streulicht / lumière directe et indirecte diffuse / luz directa y indirecta difusa

led 230VAC 2x11W / 2x1.100 lm / 2.700K / CRI80

protection rating:

IP40

Design | Interni

TensoSpot PAR30 / Tensospot AR111

Luta Bettonica, Mario Melocchi, 2010



TensoApparecchi su cavi a 230V per un'illuminazione diretta d'accento, corpo illuminante orientabile. TensoSpot PAR30 e TensoSpot AR111 con sorgente direzionale led. Apparecchi muniti di TensoClic.

A 230V cable-mounted TensoLuminaire for direct accent lighting, with a swivel lighting body. TensoSpot PAR30 and TensoSpot AR111 with directional led source. These luminaires are fitted with TensoClic.

TensoLeuchten an 230V-Spannkabeln für direkte Punktbeleuchtung, mit ausrichtbarem Leuchtenkörper. TensoSpot PAR30 und TensoSpot AR111 mit led-Scheinwerfer. Die Leuchten sind mit TensoClic Steckanschlüssen ausgestattet.

TensoAppareils sur câbles à 230V pour un éclairage direct d'accentuation avec le corps d'éclairage réglable. TensoSpot PAR30 et TensoSpot AR111 avec source directionnelle à led. Appareils munis de TensoClic.

TensoAparatos sobre cables de 230V para una iluminación directa de realce, cuerpo iluminante orientable. TensoSpot PAR30 y TensoSpot AR111 con fuente luminosa direccional led. Aparatos provistos de TensoClic.

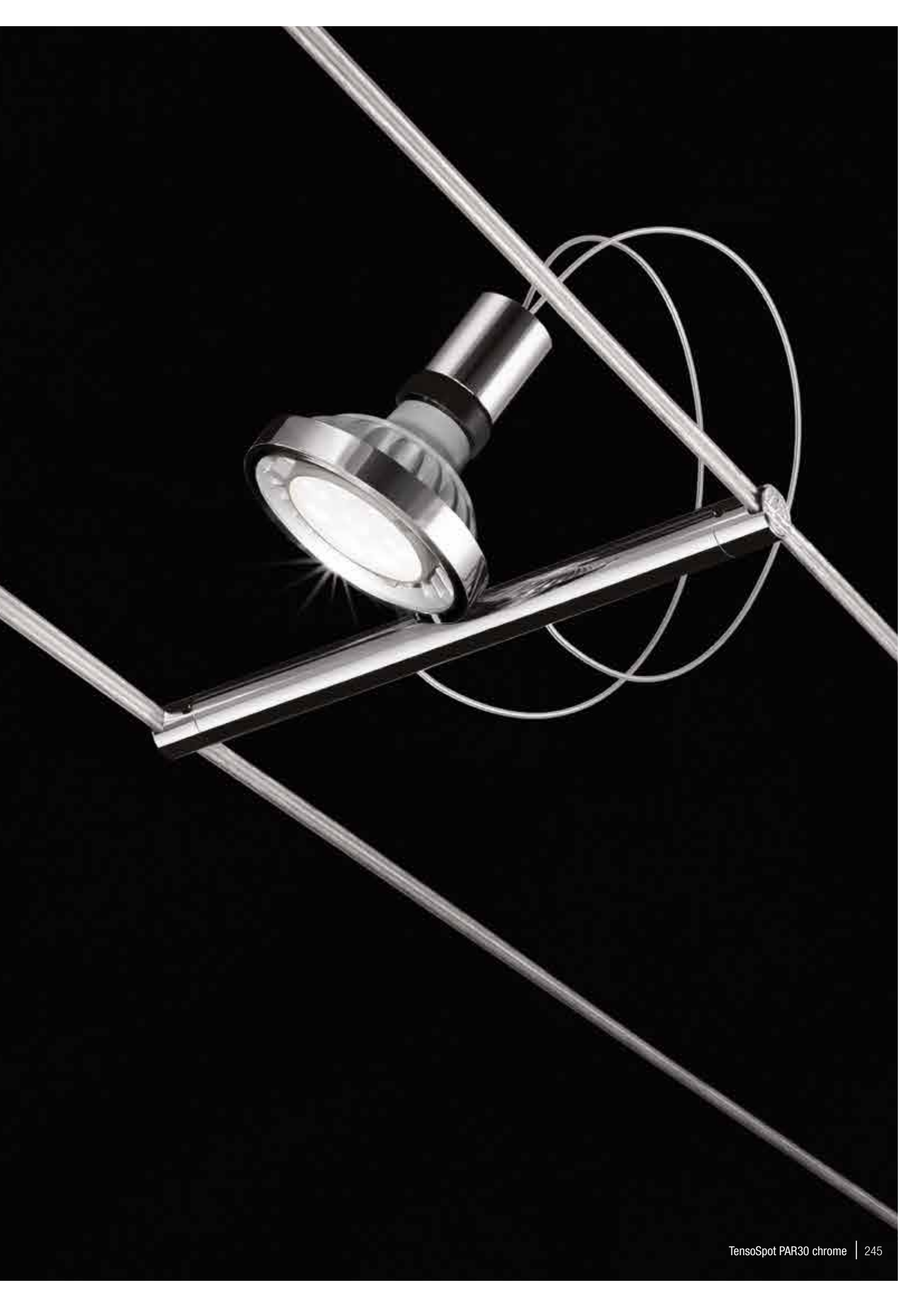



Design | Interni

TensoSpot PAR30 / AR111

Luta Bettonica, Mario Melocchi, 2010



TensoSpot PAR30

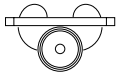

11 cm
4^{3/8}"

29 cm
11^{3/8}"

11 cm
4^{3/4}"

TensoSpot AR111

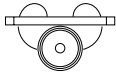

14 cm
5^{1/2}"

29 cm
11^{3/8}"

11 cm
4^{3/4}"



cromo / chrome / Chrom / chromé / cromo (only TensoSpot PAR30)



argento / silver / Silber / argent / plateado

light emission available:

luce diretta d'accento / direct pointing lighting / direktes Punktlicht /
lumière directe d'accent / luz directa de realce

TENSOSPOT PAR30

led E27 PAR30 h max 95 mm (bulb not included)

TENSOSPOT AR111

led GU10 AR111 / 220VAC (bulb not included)

newTensoled

Luta Bettonica, Mario Melocchi, 2015



TensoApparecchio led su cavi a 230V con alimentatore dimmerabile integrato. Illuminazione diretta o indiretta grazie alla rotazione del corpo illuminante. Apparecchio munito di TensoClic.

A 230V cable-mounted led TensoLuminaire with built-in dimmer and power supply. The lighting body can be rotated for direct or indirect light. This luminaire is fitted with TensoClic.

Led-TensoLeuchte an 230V-Spannkabeln mit eingebauter dimmbarer Speiseeinheit. Direkte oder indirekte Lichtausgabe durch Drehbarkeit des Leuchtenkörpers. Ausgestattet mit TensoClic.

TensoAppareil led sur câbles à 230V avec alimentation intégrée dimmable. Éclairage direct ou indirect grâce à la rotation du corps d'éclairage. Appareil muni de TensoClic.

TensoAparatos led sobre cables de 230V con alimentador regulable integrado. Iluminación directa o indirecta gracias a la rotación del cuerpo iluminante. Aparato provisto de TensoClic.





Design | Interni

newTensoled

Luta Bettonica, Mario Melocchi, 2015

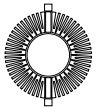

29 cm
11^{3/8}"



3,2 cm
1^{1/4}"

24,5 cm
9^{5/8}"



bianco / white / weiß / blanc / blanco



argento / silver / Silber / argent / plateado

light control available:



phase cut dimmable

light emission available:

luce diretta o indiretta / direct or indirect light / direktes oder indirektes Licht /
lumière directe ou indirecte / luz directa o indirecta

led 33W / 3.000 lm / 2.700K / CRI80

TensoFari

Franco Bettonica, Mario Melocchi, 1994



TensoApparecchi su cavi a 230V per luce diretta d'accento a uno o due corpi illuminanti orientabili in tutte le direzioni, con sorgente direzionale PAR30. Apparecchio munito di TensoClic.

230V cable-mounted TensoLuminaire for direct accent lighting with one or two lighting bodies that can be pointed in all directions and directional PAR30 source. This luminaire is fitted with TensoClic.

TensoLeuchten an 230V-Spannkabeln für direkte Punktbeleuchtung mit einem oder zwei Leuchtenkörpern, die völlig frei ausrichtbar sind. Mit PAR30-Schweinerwerfer. Ausgestattet mit TensoClic.

TensoAppareils sur câbles à 230V pour un éclairage direct d'accentuation pour un ou deux appareils d'éclairage orientables dans toutes les directions, avec source directionnelle PAR30. Appareils munis de TensoClic.

TensoAparatos sobre cables de 230V para luz directa de realce, de uno o dos cuerpos iluminantes orientables en todas las direcciones, con fuente luminosa direccional PAR30. Aparato provisto de TensoClic.



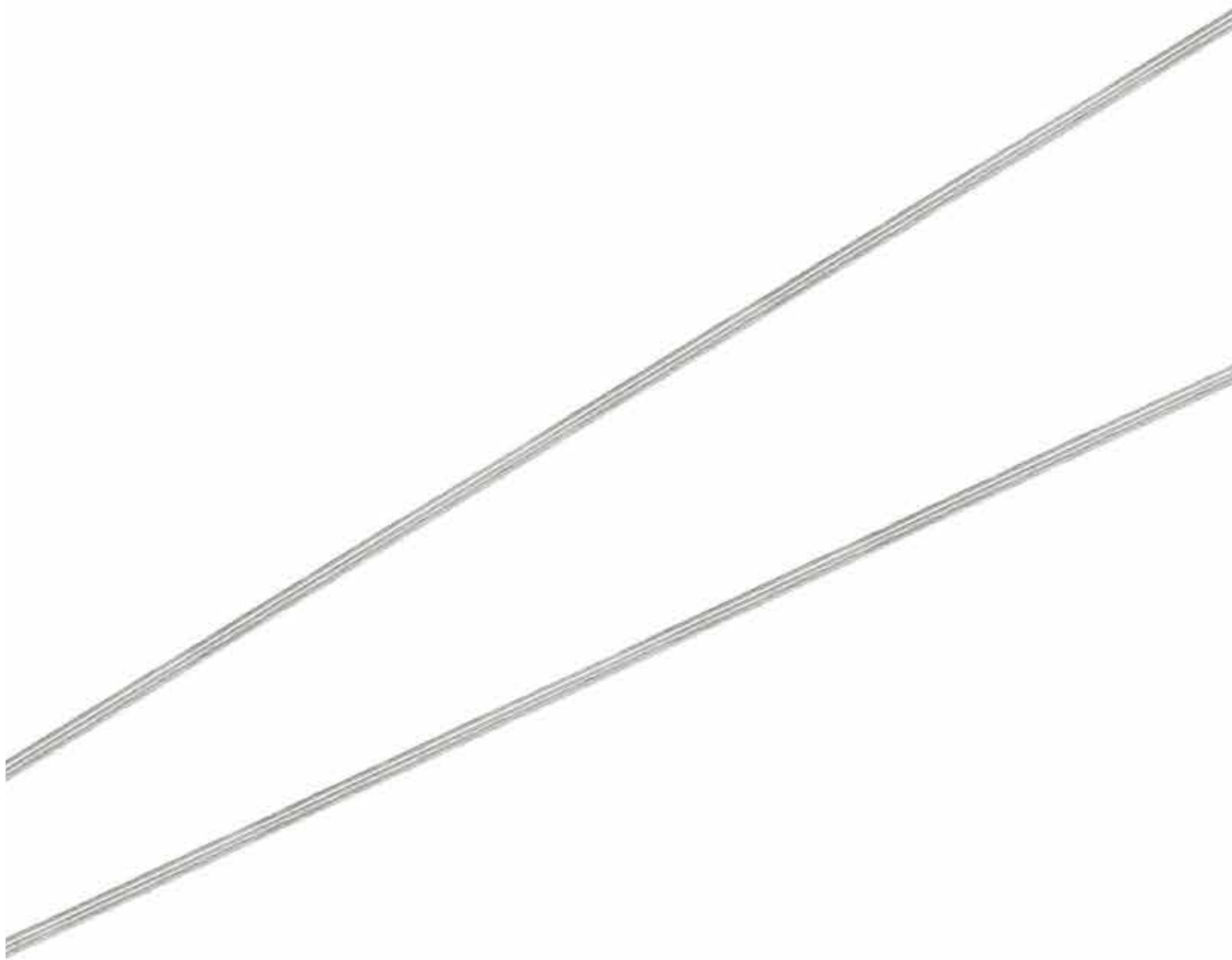





Design | Interni

TensoFari

Franco Bettonica, Mario Melocchi, 1994



TensoFariuno



29 cm
11^{3/8}"

12,5 cm
5"

 argento / silver / Silber / argent / plateado

light emission available:

luce diretta d'accento / direct pointing lighting / direktes Punktlicht / lumière
directe d'accent / luz directa de realce

led E27 PAR30 h max 95 mm (*bulb(s) not included*)

TensoFaridue

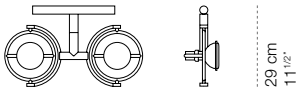

50 cm
19^{5/8}"

12,5 cm
5"

newTensoGradi

Luta Bettonica, Mario Melocchi, 2001



TensoApparecchi su cavi a 230V con sorgenti alogene lineari. Illuminazione indiretta per la versione con diffusore retinato, indiretta e diffusa per la versione opalescente, uniforme diffusa per la versione tuttopallescete. Apparecchio munito di TensoClic.

230V cable-mounted TensoLuminaire with linear halogen sources for indirect light from the version with a cross-hatched diffusor, indirect and diffused from the opalescent version and uniform diffused from the tuttopallescete version. This luminaire is fitted with TensoClic.

TensoLeuchten an 230V-Spannkabeln mit Halogen-Stablampen. Indirektlicht bei der Ausführung mit gerastertem Lichtverteiler, Indirekt- und Streulicht bei der opaleszierenden und gleichmäßiges Streulicht bei der Ausführung tuttopallescete (komplett opaleszierend). Ausgestattet mit TensoClic.

TensoAppareils sur câbles à 230V à source halogène linéaire. Éclairage indirect pour la version avec diffuseur tramé, indirect et diffus pour la version opalescente, uniforme pour la version toute-opalescente. Appareils munis de TensoClic.

TensoAparatos sobre cables de 230V con fuentes luminosas halógenas lineales. Iluminación indirecta para la versión "retinato" (difusor con rejilla), indirecta y difusa para la versión "opalescente", uniforme y difusa para la versión "tuttopallescete". Aparato provisto de TensoClic.

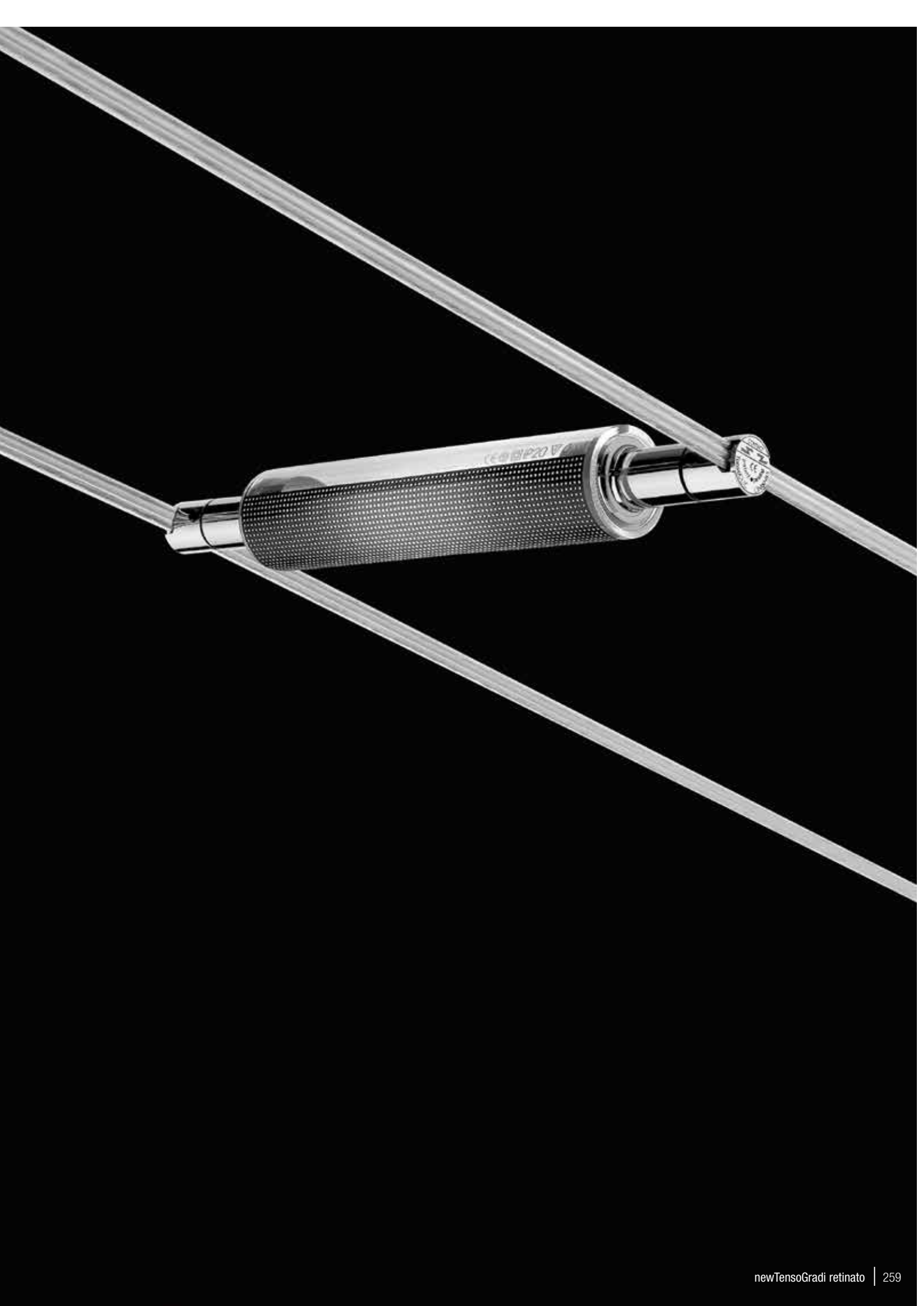

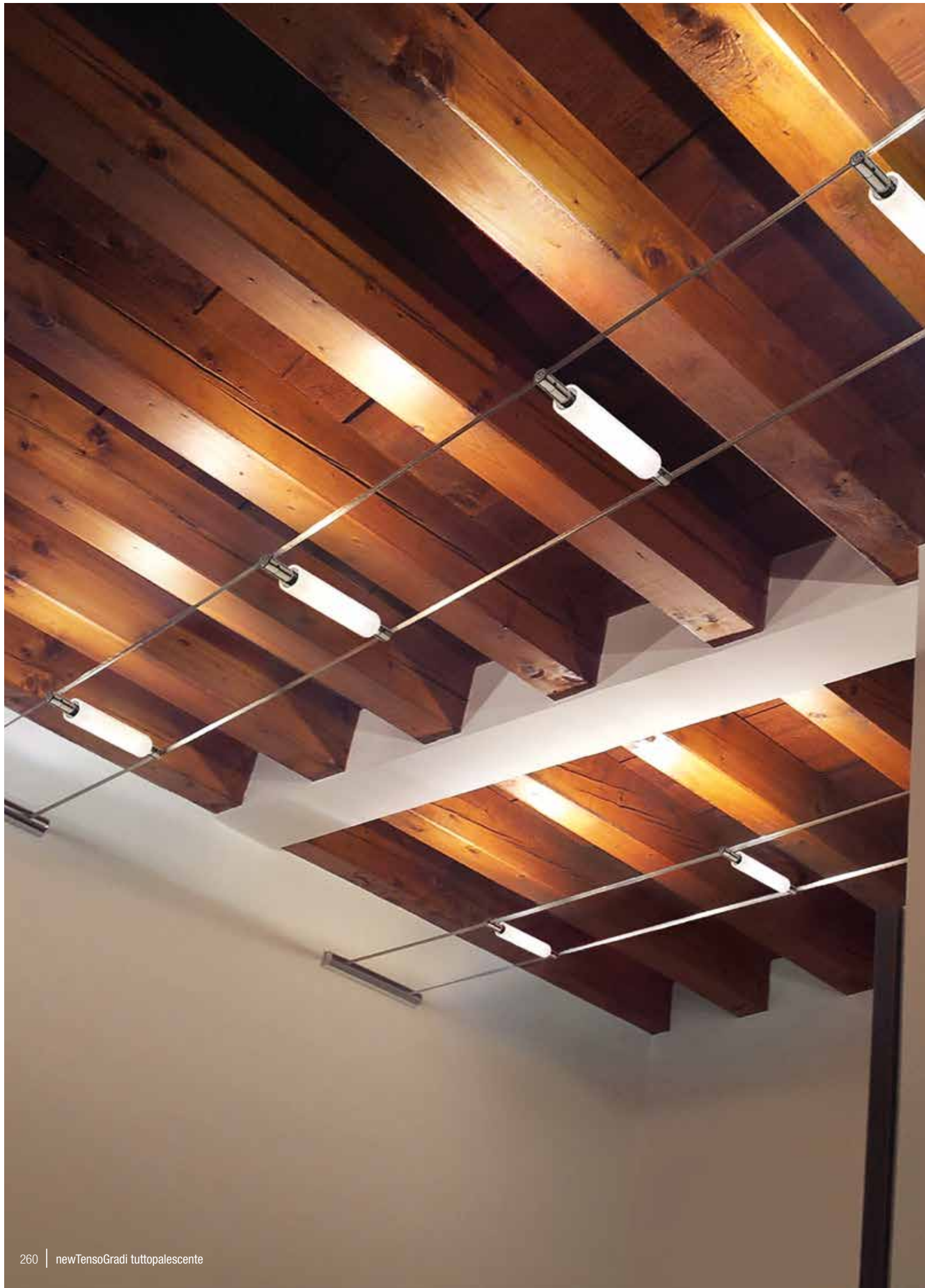

Design | Interni

new TensoGradi

Franco Bettonica, Mario Melocchi, 2001

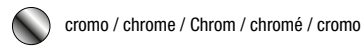
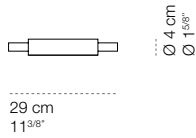

glass diffuser available:



light control available:

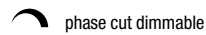

light emission available:

retinato > luce indiretta / indirect light / indirektes Licht / lumière indirecte / luz indirecta

opalescente > luce indiretta e diffusa / indirect and diffused light / indirektes und diffuses Licht / lumière indirecte et diffuse / luz indirecta y difusa

tuttopalescente > luce diffusa / diffused lighting / diffuses Licht / lumière diffuse / luz difusa

halo R7s HDG114,2 - 230W / 230V / 5.060 lm (*bulb included*)

Design | Interni

miniTenso

Franco Bettonica, Mario Melocchi, 1998

miniTensoSferico

Luta Bettonica, 2016



miniTensoApparecchio led, su cavi a 230V a doppia emissione per luce diretta e indiretta. Disponibile in versione on-off e dimmerabile da comandi tradizionali e Casambi. MiniTensoSferico con struttura bianco o argento, è corredato da calotte in metacrilato trasparente con lenti concentranti per luce puntuale oppure da calotte in metacrilato opalescente per luce diffusa. L'elegante forma sferica di soli 14 cm è ideale in piccoli e medi ambienti. Apparecchio munito di TensoClic, connettore brevettato a perforazione d'isolante.

A 230V cable-mounted led miniTensoLuminaire, with twin emission for direct and indirect light. Available in an on/off version with a dimmer fitted with traditional controls and Casambi. The miniTensoSferico with a white or silver structure comes with transparent methacrylate domes with focusing lenses for accent lighting or opalescent methacrylate domes for soft diffused lighting. This elegant little 14 cm diameter sphere is ideal in small and medium-sized rooms. This luminaire is fitted with TensoClic, the patented insulation-piercing connector.

Led-miniTensoLeuchte an 230V-Spannkabeln, mit zweifacher Lichtausgabe für Direkt- und Indirektlicht. Erhältlich als Ein/Aus- und als dimmbare Ausführung mit herkömmlichen Lichtstärkeregler und CASAMBI-Lichtsteuerung. miniTensoSferico in den Ausführungen Weiß oder Silber ist ausgestattet mit Halbkugeln aus transparentem Methacrylat mit Linsen für Punktlicht bzw. mit Halbkugeln aus opaleszierendem Methacrylat für Streulicht. Die elegante Kugelform von nur 14 cm Durchmesser eignet sich ideal für kleine bis mittelgroße Räume. Mit TensoClic, dem patentierten, die Kabelisolierung durchdringenden Steckanschluss.

miniTensoAppareil, sur câbles à 230V à double émission pour une lumière directe et indirecte. Disponible en version on-off et dimmable à l'aide de commandes traditionnelles et de Casambi. miniTensoSferico à structure blanche ou argent est équipée de calottes en méthacrylate transparent avec des lentilles concentrées pour une lumière d'accentuation ou de calottes en méthacrylate opalescent pour une lumière diffuse. L'élégante forme sphérique de seulement 14 cm est idéale dans les espaces petits et moyens. Luminaire muni de TensoClic, connecteur breveté à perforation d'isolant.

miniTensoAparatos led, sobre cables de 230V, de doble emisión para una iluminación directa e indirecta. Disponible en versión on/off y regulable con control tradicional y Casambi. miniTensoSferico con estructura de color blanco o plateado, tiene casquetes de metacrilato transparente con lentes que concentran los rayos de luz para una luz puntual, o bien casquetes de metacrilato opalescente para luz difusa. La elegante forma esférica de solo 14 cm es ideal para ambientes pequeños y medianos. Aparato provisto de TensoClic, conector patentado que perfora el aislante.

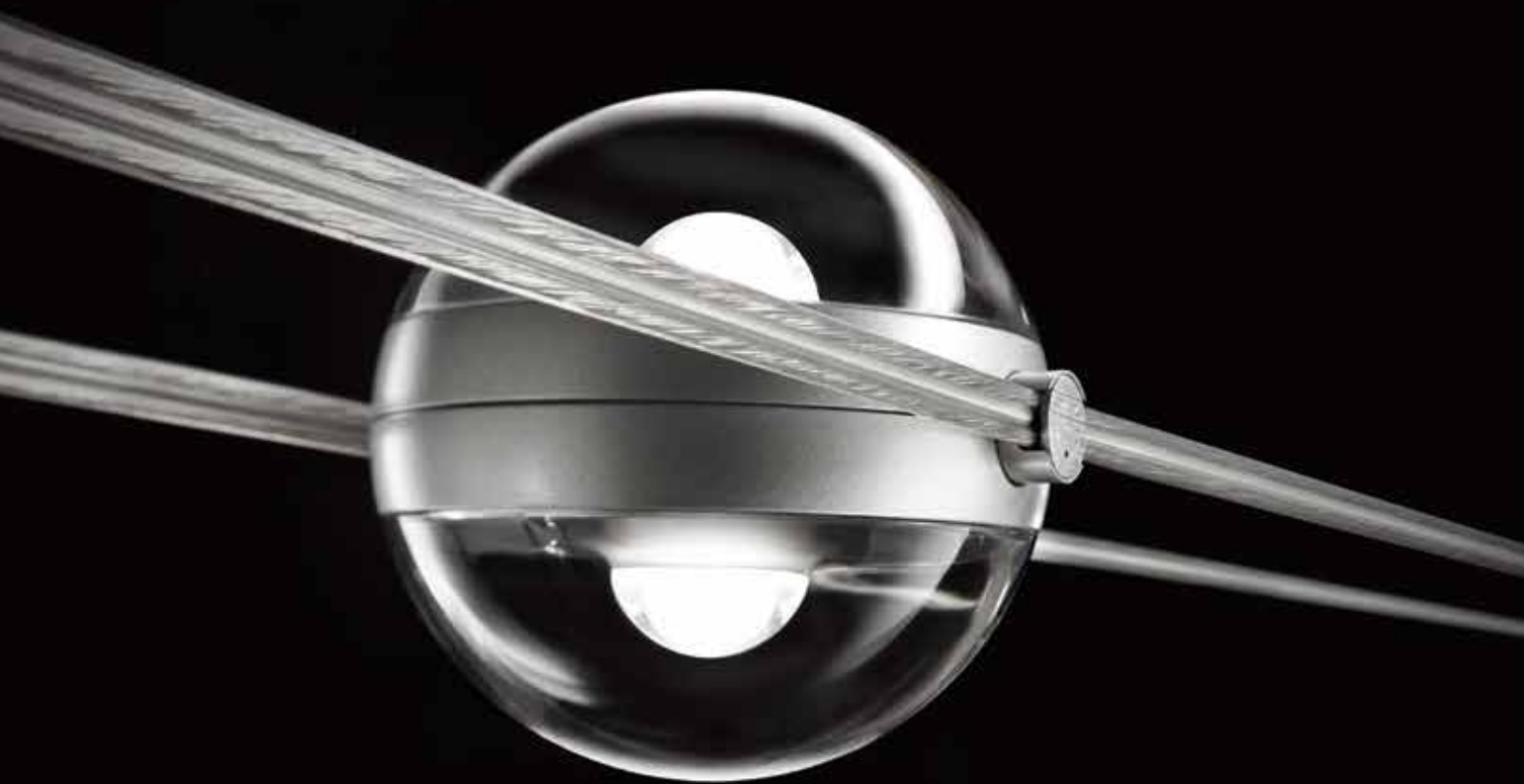







Design | Interni

miniTensoSferico

Luta Bettonica, 2016



Ø 14 cm
Ø 5 1/2"



16 cm
6 1/4"



bianco / white / weiß / blanc / blanco



argento / silver / Silber / argent / plateado

caps available:



trasparente



opalescente

light control available:



on-off



phase cut dimmable



casambi integrated

light emission available:

trasparente > luce diretta e indiretta concentrata / direct and indirect concentrated light / direktes und indirektes konzentriertes Licht / lumière directe et indirecte concentrée / luz directa y indirecta concentrada

opalescente > luce diretta e indiretta diffusa / direct and indirect diffused light / direktes und indirektes diffuses Licht / lumière directe et indirecte diffuse / luz directa y indirecta difusa

led 2x8W / 2x1.100 lm / 2.700K / CRI80

protection rating:

IP40

miniTensoOnirico

Luta Bettonica, Mario Melocchi, 2005



miniTensoApparecchio su cavi a 230V con sorgenti alogene lineari. Illuminazione indiretta per la versione con vetrino longitudinale, indiretta e diffusa per la versione opalescente. Apparecchio munito di TensoClic.

A 230V cable-mounted miniTensoLuminaire with linear halogen sources for indirect light from the version with a longitudinal glass screen and indirect and diffused light from the opalescent version. This luminaire is fitted with TensoClic.

miniTensoLeuchte an 230V-Spannkabeln mit Halogen-Stablampen. Mit Indirektlicht bei der Ausführung mit Längsglasaufsatz, Indirekt- und Streulicht bei der opaleszierenden Ausführung. Ausgestattet mit TensoClic.

miniTensoAppareil sur câbles à 230V, aux sources halogènes linéaires. Éclairage indirect pour la version en lamelle de verre longitudinale, indirect et diffus pour la version opalescente. Appareil muni de TensoClic.

miniTensoAparato cables de 230V con fuentes luminosas halógenas lineales. Iluminación indirecta para la versión con cristal longitudinal, indirecta y difusa para la versión opalescente. Aparato provisto de TensoClic.





Design | Interni

miniTensoOnirico

Luta Bettonica, Mario Melocchi, 2005



15,7 cm
6^{1/8}"

 argento / silver / Silber / argent / plateado

glass diffuser available:

 longitudinale

 opalescente

light control available:

 phase cut dimmable

light emission available:

luce indiretta e diffusa / indirect and diffused light / indirektes und diffuses Licht /
lumière indirecte et diffuse / luz indirecta y difusa

halo R7s HDG74,9 / 120W / 230V / 2.450 lm (bulb included)

miniTensoFari

Franco Bettonica, Mario Melocchi, 1998



miniTensoApparecchio su cavi a 230V per luce diretta d'accento a uno o due corpi illuminanti orientabili in tutte le direzioni. Apparecchio munito di TensoClic.

A 230V cable-mounted miniTensoLuminaire for direct accent lighting with one or two lighting bodies that can be pointed in all directions. This luminaire is fitted with TensoClic.

miniTensoLeuchte an 230V-Spannkabeln für direkte Punktbeleuchtung mit einem oder zwei Leuchtenkörpern, die völlig frei ausrichtbar sind. Ausgestattet mit TensoClic.

miniTensoAppareil sur câbles à 230V pour une lumière directe d'accentuation à un ou deux appareils d'éclairage orientables dans toutes les directions. Appareil muni de TensoClic.

miniTensoAparato sobre cables de 230V para luz directa de realce, de uno o dos cuerpos iluminantes orientables en todas las direcciones. Aparato provisto de TensoClic.





Design | Interni

miniTensoFari

Franco Bettonica, Mario Melocchi, 1998



miniTensoFariuno



16 cm
6^{1/4}"

9,5 cm
3^{3/4}"

11 cm
4^{1/4}"

miniTensoFari due

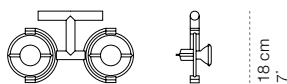

30,5 cm
12"

9,5 cm
3^{3/4}"

18 cm
7"

 cromo / chrome / Chrom / chromé / cromo

 argento / silver / Silber / argent / plateado

light control available:

 phase cut dimmable

light emission available:

luce diretta d'accento / direct pointing lighting / direktes Punktlicht / lumière directe d'accent / luz directa de realce

MINITENSOFARIUNO

led GU10 PAR16 / beam 36° / phase cut dimmable
2.700K / 4,6W / 230V / 350 lm (bulb included)

MINITENSOFARIDUE

led GU10 PAR16 / beam 36° / phase cut dimmable
2.700K / 2x4,6W / 230V / 2x350 lm (bulbs included)



Design | Esterni

TensEsterni

TensEsterni Sfera

Luta Bettonica, Mario Melocchi, 2011



TensEsterni è la versione da esterni di Tenso, sistema su cavi a 230V. Apparecchi con attacco E27, disponibili nelle versioni trasparente e opalescente per un'illuminazione diretta o diffusa su 360°, con riflettore per un'illuminazione diretta verso il basso e orientabile per creare effetti scenografici con un'illuminazione d'accento.

TensEsterni is the outdoor version of Tenso, the 230V cable-mounted system. These luminaires with an E27 attachment are available in a transparent version for direct lighting and an opalescent version for diffused lighting through 360°, with a reflector for direct downlighting that can be pointed in other directions to create theatrical effects with accent lighting.

TensEsterni ist die Außenbereichversion von Tenso, dem Beleuchtungssystem an 230V-Spannkabeln. Die Leuchten mit E27-Fassung sind in den Ausführungen transparent und opaleszierend erhältlich und gewährleisten Direktbeleuchtung oder Streulicht über 360°, mit Reflektor für Direktlicht nach unten, der auch schwenkbar ist, um suggestive Lichtakzente zu ermöglichen.

TensEsterni est la version pour extérieurs de Tenso, un système sur câble à 230V. Luminaires avec culot E27, disponibles en versions transparente et opalescente pour un éclairage direct ou diffus sur 360°, avec un réflecteur pour un éclairage direct orienté vers le bas et un éclairage d'accentuation pour créer des effets scénographiques.

TensEsterni es la versión para exteriores de Tenso, sistema sobre cables de 230V. Aparatos con casquillo E27, disponible en las versiones transparente y opalescente para una iluminación directa o difusa en 360°, con reflector para una iluminación directa hacia abajo y orientable para crear efectos escenográficos con una iluminación de realce.





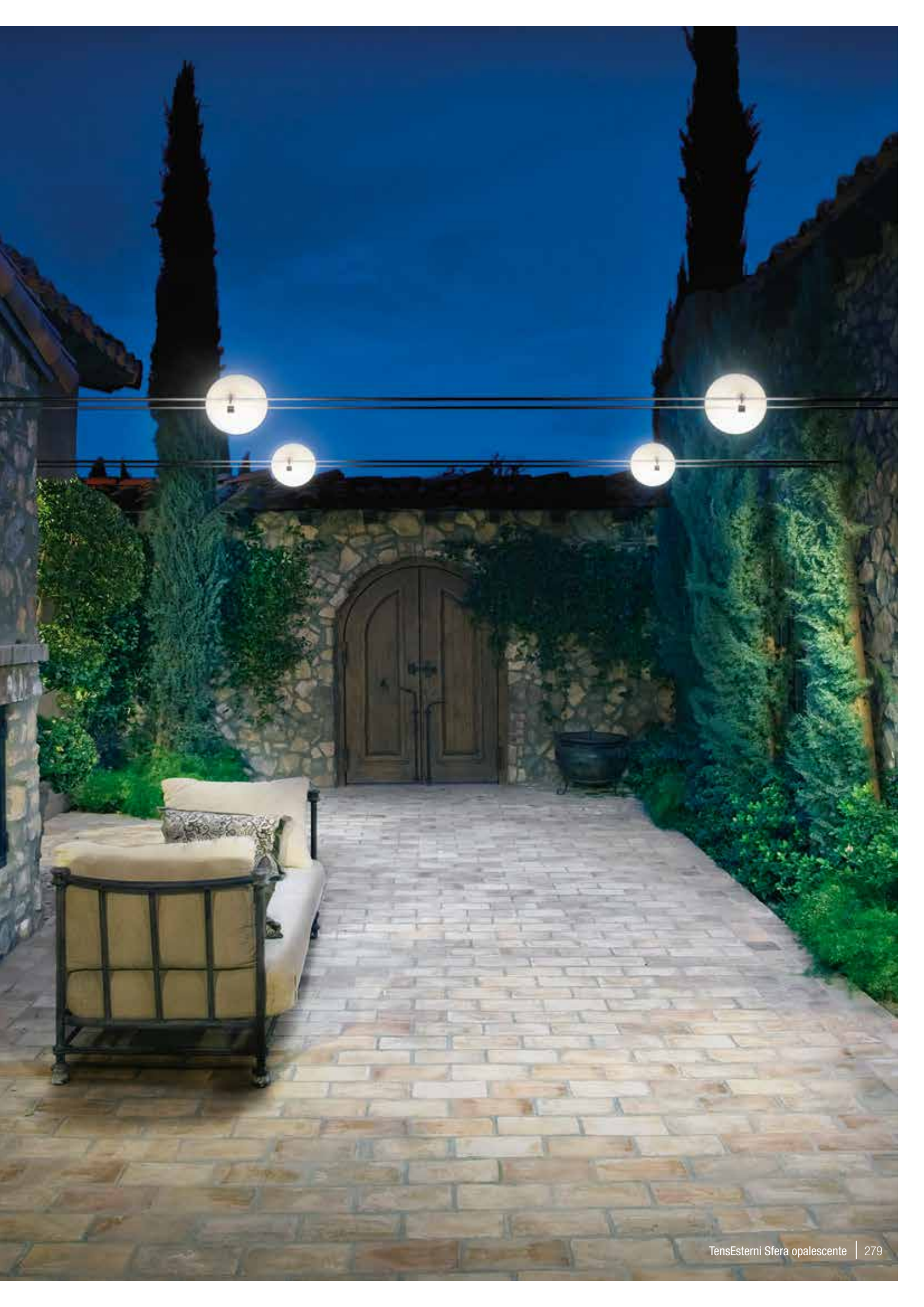



TensEsterni Sfera

Luta Bettonica, Mario Melocchi, 2011



21,8 cm
8 1/2"



Ø 24 cm
Ø 9 1/2"

TensEsterni Sfera opalescente



○ opalescente / opalescent / opaleszierend / opalescente / opalescente

Luce diffusa su 360° per illuminazione soft / Ambient light over 360° for soft illumination / Streulicht über 360° zur dezenten Beleuchtung / Lumière diffuse sur 360° pour éclairage soft (doux) / Luz difusa en 360° para iluminación suave

led E27 max 70W (bulb not included)

protection rating:
IP65

TensEsterni Sfera trasparente



○ trasparente / transparent / transparent / transparent / transparente

Luce diffusa su 360° per illuminazione intensa / Direct light over 360° for intense illumination / Direktlicht über 360° zur starken Beleuchtung / Lumière directe sur 360° pour éclairage intense / Luz directa en 360° para iluminación intensa

led E27 max 70W (bulb not included)

protection rating:
IP65

TensEsterni Sfera con riflettore



○ opalescente-trasparente / opalescent-transparent / opaleszierend-transparent / opalescente-transparent / opalescente-transparente

Luce diretta verso il basso per tavoli, zone di lettura / Direct down light for tables and reading areas / Direktlicht nach unten für Tische und zum Lesen / Lumière directe vers le bas, pour éclairage de tables, zones de lecture / Luz directa hacia abajo para mesas, zonas de lectura

led E27 max 70W (bulb not included)

protection rating:
IP65

TensEsterni Sfera orientabile



○ trasparente / transparent / transparent / transparent / transparente

Luce d'accento orientabile per effetti scenografici su alberi, cespugli, dettagli architettonici, arredi / Swivel accent light for theatrical effects on trees, shrubs, architectural details or furnishings / Ausrichtbares Punktlicht für szenographische Effekte (auf Bäume, Büsche, architektonische Details, Möbel u. a.) / Lumière d'accent orientable pour un effet scénographique sur arbres, buissons, détails architecturaux, ameublements / Luz de realce orientable para efectos escenográficos en árboles, matorrales, detalles arquitectónicos, decoraciones

led E27 PAR 30 max 70W (bulb not included)

protection rating:
IP65

Design | Interni

Fari

Franco Bettonica, Mario Melocchi, 1996



Apparecchi da soffitto e parete per luce diretta d'accento a uno o due corpi illuminanti orientabili in tutte le direzioni, con sorgente PAR30.

Ceiling and wall luminaires for direct accent lighting with one or two lighting bodies that can be pointed in all directions, with a PAR30 source.

Decken- und Wandleuchten für direkte Punktbeleuchtung mit einem oder zwei Leuchtenkörpern, die völlig frei ausrichtbar sind. Mit PAR30-Leuchtmittel.

Appareils pour plafond et mur pour un éclairage d'accentuation à un ou deux modules orientables dans toutes les directions, à source PAR30.

Aparatos de techo y de pared para luz directa de realce, de uno o dos cuerpos iluminantes orientables en todas las direcciones, con fuente PAR30.





Design | Interni

Fari

Franco Bettonica, Mario Melocchi, 1994



Fariuno parete|soffitto

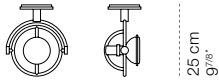

21,5 cm
8 1/2"

12,5 cm
5"

 argento / silver / Silber / argent / plateado

light emission available:

luce diretta d'accento / direct pointing lighting / direktes Punktlicht / lumière
directe d'accent / luz directa de realce

led E27 PAR30 h max 95mm (*bulb(s) not included*)

Faridue parete|soffitto

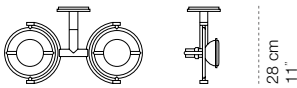

50 cm
19 1/2"

12,5 cm
5"

28 cm
11"

Design | Interni

miniFari

Franco Bettonica, Mario Melocchi, 1998



Apparecchi da soffitto e parete per luce diretta d'accento a uno o due corpi illuminanti orientabili in tutte le direzioni, con sorgente attacco GU10.

Ceiling and wall luminaires for direct accent lighting with one or two lighting bodies that can be pointed in all directions, with a GU10 source attachment.

Decken- und Wandleuchten für direkte Punktbeleuchtung mit einem oder zwei Leuchtenkörpern, die völlig frei ausrichtbar sind. Mit GU10-Fassung.

Appareils pour plafond et mur pour l'éclairage d'accentuation à un ou deux modules orientables dans toutes les directions, à source GU10.

Aparatos de techo y de pared para luz directa de realce, de uno o dos cuerpos iluminantes orientables en todas las direcciones, con fuente de casquillo GU10.









miniFari

Franco Bettonica, Mario Melocchi, 1998



miniFariuno parete|soffitto



13,3 cm
5 1/4"

9,5 cm
3 3/4"

15 cm
6"

miniFariuno parete|soffitto 25

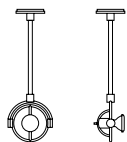

13,3 cm
5 1/4"

9,5 cm
3 3/4"

39 cm
15 3/8"

miniFariuno soffitto 50

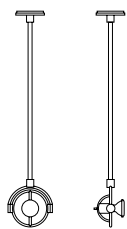

13,3 cm
5 1/4"

9,5 cm
3 3/4"

64 cm
25 1/4"

miniFariuno soffitto 100

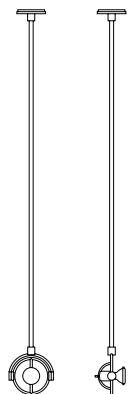

13,3 cm
5 1/4"

9,5 cm
3 3/4"

114 cm
44 7/8"

miniFaridue parete|soffitto

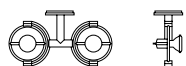

30,5 cm
12"

9,5 cm
3 3/4"

17 cm
6 3/4"



cromo / chrome / Chrom / chromé / cromo



argento / silver / Silber / argent / plateado

light control available:



phase cut dimmable

light emission available:

luce diretta d'accento / direct pointing lighting / direktes Punktlicht / lumière directe d'accent / luz directa de realce

MINIFARIUNO

led GU10 PAR16 / beam 36° / phase cut dimmable
2.700K / 4,6W / 230V / 350 lm (bulb included)

MINIFARIDUE

led GU10 PAR16 / beam 36° / phase cut dimmable
2.700K / 2x4,6W / 230V / 2x350 lm (bulbs included)

Reservations

Cini&Nils srl si riserva la facoltà di apportare modifiche ai prodotti presenti su questo catalogo in qualsiasi momento e senza preavviso.

Cini&Nils srl reserves the right to make changes on the products on this catalogue at any time and without prior notice.

Cini&Nils S.r.l. behält sich jederzeit Änderungen an den in diesem Katalog genannten Produkten vor.

Cini&Nils srl se réserve le droit d'apporter des modifications aux produits présents sur cette catalogue à tout moment et sans préavis.

Cini&Nils srl se reserva la facultad de modificar los productos presentes en este catálogo en cualquier momento y sin aviso previo.

Energy label

Energy label Regolamento Europeo 874/2012 - Direttiva 2010/30/UE disponibili nell'area download del sito cinienils.com

Energy label European Regulation 874/2012 - Directive 2010/30/UE available on cinienils.com download area.

Energieverbrauchskennzeichnung EU-Verordnung 874/2012: verfügbar unter dem Link "download" unserer Website "cinienils.com".

Étiquette énergie Régulation Européenne 874/2012 - Directive 2010/30/UE disponibles dans l'aire download de cinienils.com

Reglamento Europeo sobre el etiquetado energético 874/2012 - Directiva 2010/30/UE disponibles en el área bajar (download) del sitio web cinienils.com.

Copyright © 2023

I testi e le immagini sono
protetti da diritti d'autore.
Riproduzione non autorizzata.

All texts and images are
protected by copyright.
Reproduction prohibited.

Alle Texte und Abbildungen
sind urheberrechtlich geschützt.
Keine unerlaubte Vervielfältigung.

Les textes et les images sont
protégés par des droits d'auteur.
Reproduction interdite.

Los textos y las imágenes están
protegidas por derechos de autor.
Reproducción no autorizada.

Photo product

Curti Parini
Simona Pesarini
Stefano Pasini
Studio Pointer
Thomas Libis
varianti.it

Photography

Andrea Martiradonna
Armando Melocchi
Delfino Sisto Legnani
Edo Mari
Ettore Buganza
Giampietro Agostini
Lucio Arboit
Luigi Filetici
Mathieu Goradesky
Matteo Cappè
Nancy Fina
Stefanacci e Ciarlo

Art Direction

Valentina Colombo Condivisa.it

Graphic Revisions

Alessandra Chiara Lamanna

Print

LITOPAT S.r.l.
09/2023

A special thanks to

Acerbis International
Alf Uno spa
Arch. Attilio Panzeri
Black Tie srl
Confagricoltura
Former
IVM
Jesse
lapalma
MDF Italia
Molteni&C
Poliform
Sculptures Jeux s.r.l.
Sorin
Varenna





via Pizzigoni 3
24060 Villongo (BG)
Italia

T + 39 02 3343071
T + 39 035 939411
info@cinienils.com

cinienils.com